

Conspiracies • Behind the News • Health • UFOs • Future Science

NEXUS

NEW TIMES • Vol 6, No 1

DECEMBER 1998 – JANUARY 1999

AUSTRALIA	\$4.95
NZ (incl GST)	NZD \$5.95
USA	USD \$4.95
CANADA	CAN \$6.95
UK	STG £2.50
NETHERLANDS	NFL f8.95

The Margarine Conspiracy

Just who controls the global money supply?

Terminator Technology: the big business of seed control

Construction secrets of the Great Pyramid

Perpetual Motion: the story of Bessler's Wheel

ISSN 1039-0170 12



9 771039 017000

Print-Post Approved PP4420362005

• UFOs in the Vietnam War • Star Fire: Gold of the Gods •

NEXUS

NEW TIMES MAGAZINE

Volume 6, Number 1 DECEMBER 1998 – JANUARY 1999

PO Box 30, Mapleton Qld 4560, Australia

CONTENTS

LETTERS TO THE EDITOR.....	4	PERPETUAL MOTION: BESSLER'S WHEEL.....	53
GLOBAL NEWS.....	6	<i>By John Collins. Amidst the heated debate over perpetual motion in the early 1700s, the successful demonstration of a gravity-propelled wheel caused huge controversy for its inventor, Johann Bessler.</i>	
<i>This issue, our round-up of the news includes an exposé of a troublesome and persistent class of water pollutant: pharmaceutical drugs.</i>		THE TWILIGHT ZONE.....	59
CENTRAL BANKING—Part 1.....	11	<i>Strange tales from around/within/beyond the world. This issue, former NASA astronaut Edgar Mitchell speaks out on ETs, Richard Boylan reports on monoliths and a secret space station in orbit, and Spain's Air Force declassifies its UFO files.</i>	
<i>From "The Money Masters". Whoever controls the money supply controls governments and the people. These last few centuries, that control has been exerted by privately owned central banks.</i>		MILITARY/ET CONTACT IN VIETNAM WAR.....	63
THE OILING OF AMERICA—Part 1.....	19	<i>By Linda Moulton Howe. A retired US Army Special Forces officer tells of a close encounter with humanoid aliens—and with the MJ-12 and CIA—while on secret assignment in Cambodia.</i>	
<i>By Mary G. Enig and Sally Fallon. The massive rise in heart disease in the US may be due to people consuming more foods high in hydrogenated vegetable oils, in response to campaigns promoting their benefits over animal fats.</i>		REVIEWS—Books.....	69
TERMINATOR TECHNOLOGY.....	25	<i>"The Forgotten Monarchy of Scotland" by Prince Michael of Albany</i>	
<i>By Martha L. Crouch. A patented but untested genetic engineering technique for killing second-generation seeds has serious implications for human health and the survival of ecosystems.</i>		<i>"Time Travelers From Our Future" by Dr Bruce Goldberg</i>	
STAR FIRE: THE GOLD OF THE GODS—Part 2.....	33	<i>"The Head of God: Lost Treasure of the Templars" by Keith Laidler</i>	
<i>By Sir Laurence Gardner. With the departure of the Anunnaki 'gods', the Sumerian Master Craftsmen created a Star Fire substitute: a mystical bread made from the alchemical white powder of gold.</i>		<i>"Too Much Medicine?" by Ray Moynihan</i>	
BUILDING THE GREAT PYRAMID AT GIZEH.....	41	<i>"Free Energy Pioneer: John Worrell Keely" by Theo Pajmans</i>	
<i>An interview with Richard Noone by Alex Horvat. According to this theory on how the Great Pyramid was built, a pump system was incorporated into the structure, and water and chemical power were used to raise the massive blocks to higher levels.</i>		<i>"The Chinese Roswell" by Hartwig Hausdorf</i>	
NEW SCIENCE NEWS.....	49	<i>"The Manipulators" by Jeffrey Robinson</i>	
<i>Interesting news/views from the underground science network. Here, we reprint Frank Prentice's 1923 patent for electrical power accumulators that can tap directly into Earth energy.</i>		<i>"Altered Genes: The Debate" edited by Richard Hindmarsh et al.</i>	
		<i>"The Seventh Millennium" by John F. Ashton, PhD</i>	
		<i>"Scorched Earth" by William Thomas</i>	
		<i>"The Cosmic Game" by Stanislav Grof</i>	
		<i>"The Harmonic Conquest of Space" by Bruce Cathie (new edition)</i>	
		<i>"Mapping the Millennium" by Terry M. Boardman</i>	
		<i>"Science versus Truth" by Cameron Horn</i>	
		<i>"It's Not Too Late" by Hamish Miller</i>	
		REVIEWS—Videos.....	76
		<i>"Merkabah: Voyage of a Star Seed" by J. J. Hurtak & J.-L. Bozzoli</i>	
		<i>"UFOs: The Footage Archives" by 2000 Film Productions</i>	
		REVIEWS—Audio.....	77
		<i>"Environment" by Vulcan's Child</i>	
		<i>"Venus, Sculptress of Love" by Raymond Oliver & Ray Vanderby</i>	
		<i>"Journey Between" by Baka Beyond</i>	
		<i>"Afro-Latino" by various artists</i>	
		<i>"Ceremonies" by Armen Chakmakian</i>	
		DE-CLASSIFIEDS.....	85
		NEXUS BOOKS, SUBS, AD RATES & VIDEOS.....	89

NEXUS MAGAZINE

Volume 6, Number 1

DECEMBER 1998 – JANUARY 1999

PUBLISHED BY

NEXUS Magazine Pty Ltd, ACN #003 611 434

EDITOR

Duncan M. Roads

CO-EDITOR

Catherine Simons

ASSISTANT EDITOR/SUB-EDITOR

Ruth Parnell

EDITORS' ASSISTANT

Richard Giles

OFFICE ADMINISTRATOR

Janine Carmichael

CONTRIBUTORS THIS ISSUE

Patrick Carnack; Mary G. Enig, PhD; Sally Fallon; Martha L. Crouch; Sir Laurence Gardner, Kt St Gm., KCD, Kt St A.; Alexander Horvat; Richard W. Noone; John Collins; Linda Moulton Howe

LAYOUT & DESIGN

Duncan M. Roads

CARTOONS

Phil Somerville

COVER GRAPHIC

John Cook, jscook@ozemail.com.au

PRINTING

Warwick Daily News, Queensland, Australia

AUSTRALIAN DISTRIBUTION

Newsagents Direct Distribution

HEAD OFFICE - All Correspondence

PO Box 30, Mapleton, Qld 4560, Australia.

Ph: (07) 5442 9280; Fax: (07) 5442 9381

E-mail address: nexus@peg.apc.org

Web page: <http://www.peg.apc.org/~nexus/>

NEW ZEALAND OFFICE - PO Box 226, Russell,

Bay of Islands. Ph: +64 (0)9 403 8193;

Fax: +64 (0)9 403 8196;

E-mail address: nexusnz@xtra.co.nz

USA OFFICE - PO Box 177, Kempton, IL 60946-

0177. Ph: (815) 253 6464; Fax: (815) 253 6454

E-mail address: nexususa@earthlink.net

UK OFFICE - 55 Queens Rd, East Grinstead, West

Sussex, RH19 1BG. Ph: +44 (0)1342 322854;

Fax: +44 (0)1342 324574;

E-mail address: nexus@ukoffice.u-net.com

EUROPE OFFICE - PO Box 372, 8250 AJ Dronten,

The Netherlands. Ph: +31 (0)321 380558;

Fax: +31 (0)321 318892;

E-mail address: frontier@xs4all.nl

STATEMENT OF PURPOSE

NEXUS recognises that humanity is undergoing a massive transformation. With this in mind, NEXUS seeks to provide 'hard-to-get' information so as to assist people through these changes. NEXUS is not linked to any religious, philosophical or political ideology or organisation.

PERMISSION-TO-REPRODUCE POLICY

While reproduction and dissemination of the information in NEXUS is actively encouraged, anyone caught making a buck out of it, without our express permission, will be in trouble when we catch them!

Editorial

Welcome again to the pages of NEXUS. As usual, this issue brings you a feast of information designed to loosen your grip on consensus reality!

The "Money Changers" video that I reviewed two issues ago was so good that I couldn't help myself: we are now running a two-part article on the subject. It was refreshing to see that someone can research and present the history of the control of currency without resorting to blaming one particular race or religion as being 'behind it all'. Whoever the Money Changers were or are is largely irrelevant. The bottom line is that a currency only has value because we all agree it has. Nothing more!

Each time I visit the USA, I am always amazed to see how many people are overweight, and I mean *seriously* overweight. This is despite their eating vast quantities of low-fat/no-fat food. The "Oiling of America" article should be read by everyone who believes in the myth that low-fat/no-fat diets will help them lose weight. Wakey, wakey!

The "Terminator Technology" article has nothing to do with Arnie, although I wouldn't lose sleep at the thought of his running amok through the headquarters of various transnational genetics/chemical companies! The article explores the risks inherent in a new genetic-engineering technology which can render second-generation seeds infertile.

Much has been written, and many are the theories about the construction of the Great Pyramid at Gizeh. One of our favourites is the water-pump theory as proposed by Edward Kunkel and, more recently, championed by Richard Noone, author of *5/5/2000*. So simple and yet so powerful (the theory, that is)!

I'm looking for feedback from people who served in Vietnam (or the surrounding areas) during the war years, on the subject of UFOs. I have already met and interviewed several people who told me of their experiences with UFOs during the war. When Linda Moulton Howe visited Australia for the NEXUS Conference in 1997, we were able to swap many stories regarding what we had heard. The article this issue, which is extracted from her excellent book, *Glimpses of Other Realities - Volume II*, should leave you with some idea that not only did such events happen often, but the Americans (at least some of them) were aware of them. In fact, as you'll read, the debriefing of the event sounds worse than their encounter with the little humanoids in the jungle!

The growing popularity of NEXUS never ceases to amaze me. The magazine is currently published in Australia, New Zealand, UK/Europe and USA/Canada and distributed in South-East Asia in English, and translated for Greek, Italian, Japanese, Polish, Swedish and now French editions. We extend a warm welcome to our new readers from afar!

It seems that so many people share our interest in the unusual, the unexplained and the unreported. Given that we break the unspoken rules of magazine publishing, i.e., we have no colour pictures or glossy paper inside, no trendy layout styles, articles run over two or (gasp!) three issues, etc., etc., the fact that an increasing number of readers keep coming back for more obviously reflects their interest in the content over the presentation of the articles we publish. It would appear that NEXUS readers don't want pre-digested, pre-wrapped, low-fat, low-cal, sugar-free, high-gloss information. For this we salute you, and thank you all for your continued support.

I know that I speak for all the NEXUS workers around the world when I wish you a happy and healthy festive season, and a dynamic 1999!

Duncan

WARRANTY AND INDEMNITY

Advertisers upon and by lodging material with the Publisher for publication or authorising or approving of the publication of any material INDEMNIFY the Publisher and its servants and agents against all liability claims or proceedings whatsoever arising from the publication and without limiting the generality of the foregoing to indemnify each of them in relation to defamation, slander of title, breach of copyright, infringement of trademarks or names of publication titles, unfair competition or trade practices, royalties or violation of rights or privacy AND WARRANT that the material complies with all relevant laws and regulations and that its publication will not give rise to any rights against or liabilities in the Publisher, its servants or agents and in particular that nothing therein is capable of being misleading or deceptive or otherwise in breach of the Part V of the Trade Practices Act 1974. All expressions of opinion are published on the basis that they are not to be regarded as expressing the opinion of the Publisher or its servants or agents. Editorial advice is not specific and readers are advised to seek professional help for individual problems.

© NEXUS New Times 1998/1999

Letters to the Editor ...

Dairy and Soy Alternative

Dear Mr Roads: Further to your comments in reply to David and Sandra Cooper's letter [5/06] concerning alternatives to dairy and soybean, we would like to suggest Nanny Goat Milk Infant Nutrition. This is produced by a company called Vitacare Ltd, in New Zealand, and contains neither soya nor dairy.

We used it to supplement our baby's food from about six weeks, and he was on it full-time from three months onward. At eight months, Finn is in the top 10 per cent for his age, weighs in at a healthy 23 pounds, and has bags of energy (bearing in mind that he is non-vaccinated and his mother is a homoeopath).

Yours sincerely,

Mish Lucas Craddock and David Pagden, deepster@mcdeepfinn.demon.co.uk

Wild Reaction to Aspartame

Thank you very much for your article on aspartame [see NEXUS 2/28 & 3/01 or website]. I have recently overhauled my diet because I felt so strongly that something was wrong and it was causing terrible mood swings. I had begun to think that I might be suffering from a mild psychological disorder and was seriously beginning to consider seeing a psychiatrist.

The change to my diet has had the desired effect. Having just now read your article, I think I may now know why. I was previously drinking up to two litres of diet cola a day. Now it is a can or two every day. Tomorrow it will be zero.

It is disturbing how much of your article described what I have been suffering from.

Steven Ryan, Western Australia, loki@gold.net.au

ET Message for Planet Earth!

Dear All: I have been an 'experimenter' since I was a child. I have had numerous surgeries performed by the ETs and have been fearful of them because I didn't understand why they did what they did to me.

Since May of 1998, I gave up my fear and all resentments and asked for the ETs to tell me why. Since then, my ET guide has given me incredible experiences that I wish I could share with all of you. He has shown me the future and has filled my heart with hope. Most recently,

he gave me an implant that has totally baffled my doctor. At first I wasn't sure if it was good, but since then I have been able to experience some of the most fabulous changes in my life that one could ever hope for. I didn't think I was worthy of such communications and teachings, but apparently *they* did.

When I asked to be able to remember my trips, they took me aboard a transporter ship to a huge dome-shaped ship and showed me some of their technology.

They can cure all illnesses and diseases, but do it only for those who have special missions to fulfill. They tell me that some humans create their own illnesses as a way of leaving this Earth; some have another lifetime to begin and can't do it until they end this one. They explained so much to me, yet I still have much to learn from them.

I have been asked to pass on a message from them to all people of Earth. It is their explanation of how to survive the coming Earth changes and move into the next era of Earth life. This is their message, not mine. To survive the Earth changes and move into the next era, this is what the ETs say must occur:

"Only when we let go of greed, judgement and prejudice can we truly love, and through that love we will evolve into greater spiritual beings, one with God and one with the Universe. All that is, is God."

I've been asked to present this message, not to take credit for it but only to reinforce the awareness that we are all one with God.

I am one of thousands who will be trying to communicate this and similar messages to the world before it is too late. If you wish to contact me or ask me questions, please feel free to do so.

Thank you.

Cynthia Holt, ctholt@worldnet.att.net

Neurophone Aids Hearing

I wanted to take this time to share with you my awesome experience with the Neurophone, invented by Dr Patrick Flanagan [NEXUS 2/18], in the hope that my experience would help others.

Let me tell you what led up to my trying the Neurophone. I have been wearing hearing aids now for almost a decade. I can't tell you exactly what happened to my hearing (there are several possibilities),

but, regardless of that, I cannot hear. Without my hearing aids, I basically hear nothing. If you stood with your mouth to my ear and yelled, I'd hear you; but if we were to sit together and you were talking, I would not hear you. When I take out my hearing aids, it is silent.

When I first heard about the Neurophone, I was sceptical because I didn't understand how this could possibly work; but I knew I would be the right person to try it because there is no way I could hear with my ears, so if I took my hearing aids out and used the Neurophone, the truth would be known.

So, that's what I did. I removed my aids and tried it. It was the most amazing thing I have ever heard! I could hear! I was able to hear immediately. I played a CD on my CD player, turned the volume off and took my hearing aids out, put the Neurophone on, and I could hear. It was unbelievable! There was no doubt in my mind that the Neurophone really worked because I could hear when I had the Neurophone headset on. (It's not really a headset; you don't put it on your ears. It looks like one, but you just make contact with it on your skin. I used it on my temples and my fingers.) Anyway, when it was contacting with my skin, I could hear; and as soon as I broke contact, it stopped. It truly was amazing.

My husband tried it, and he could hear; so did my children and many of my friends. Everyone who tried it experienced the same thing as I did.

Dr Patrick Flanagan has invented something amazing here, and I don't think we've even begun to hear about how this Neurophone is going to help people. There's no doubt in my mind that we will be 'hearing' a lot more about it.

Cynthia Saville, saviller@cadvision.com

Tsunami Threat to East Coast

Dear Duncan and crew: Nearly three years ago now, the CSIRO announced that the coast of eastern Australia had been struck by a large tsunami just 30 years before the arrival of Captain Cook. This wave measured 130 metres high in Sydney and 80 metres in Cairns.

Aside from raising questions about local Aboriginal survival rates and the nature of coastal flora,

the CSIRO's further findings bear urgent consideration. After analysis and dating of 'erratic' boulders perched anomalously on clifftops, and high, recent 'beach' sediments, CSIRO has found evidence of numerous wave events over the past few thousand years.

These lead researchers to estimate the risk of a 100-metre (average height) tidal wave as 15 per cent per century. It has been about 250 years since the last one. Every soul living on the east coast has an almost 50 per cent chance of being directly affected in their lifetime...

R. Ayana (NEXUS co-founder), Bowraville, NSW, Australia

Vegans are Life-Wishers!

I regret spending \$4.95 on my first copy of NEXUS. Whilst I applaud your attempts to keep our minds open, I am shocked by the harmful, insulting, misinformation found in the article, "Renewed Hope Against AIDS", by Robert Beck [5/05].

Quote: "...avoid nicotine addicts, vegans and other unconsciously motivated death-wishers..."??? "True vegetarian diets are missing essential amino acids...necessary for the successful rebuilding of AIDS-ravaged tissues"???

Dr Beck is years behind the times and seriously in error. Only the beef barons would take this statement seriously.

To quote Dr Neal Barnard (mentioned in your excellent article on the dangers of dairy products [5/05]): "Any variety of plant foods provides complete protein." Dr Barnard would be horrified to read the quotes from Dr Beck.

Humans, primates, elephants, rhinoceroses, cows, sheep and many other mammals build tissue from plant matter and are *not* missing any essential amino acids.

To lump vegans with nicotine addicts is doubly offensive. Vegans are not "unconsciously motivated death-wishers". On the contrary, we are consciously motivated life-wishers. We enjoy excellent health as a side effect of eating the foods nature intended for us. Our diet is morally, ethically, nutritionally and ecologically sound.

Your article has offended a large group of thinking people. Dr Beck should rescind his ridiculous statement, and NEXUS should apologise for printing incorrect and offensive material. Perhaps you

... more Letters to the Editor

NB: Please keep letters to approx. 100-150 words in length. Ed.

could make amends by featuring some of Dr Neal Barnard's writings on the wisdom of a vegan diet.

Lois Raynor, member, Vegetarian Society of Hawaii, RAYNOR-BURCHILL@prodigy.net

[Lois, I apologise! I thought I had chopped that piece out! However, this doesn't detract from the many success stories being reported to us from readers. Ed.]

Childhood Jabs Make Addicts?

Dear Sir: Is it any wonder that we have so many young drug addicts within our society?

Babies are jabbed with a needle on the day they are born and repeatedly vaccinated throughout their young lives, supposedly to keep them healthy. They are conditioned to accept that a jab is quite normal, and, upon adolescence, it is no 'big deal' to inject themselves with the drug of their choice.

Even on the *Play School* TV programme that my three-year-old son was watching (4 August '98), in a game of doctors and nurses they were injecting a doll with a look-alike syringe. What next?

Yours sincerely, Denise K., Bonogin, Queensland, Australia

Tidal Wave Preparedness

Dear Duncan: Regarding your editorial comments in the Oct-Nov '98 issue [5/06] on tidal waves striking the east coast of Australia, I have had a gut feeling for years that this would happen, and that the event will take place shortly.

The feeling was so strong that I bought a small farm 70 miles inland at an elevation of 1,000 feet above sea level, to grow most of my food. I have also installed alternative means for heating, cooking, lighting and radio, should utility services collapse. My family think I'm a bit of a 'nut case'; maybe I am, but I can't help but listen to my intuitions and instincts.

[Name withheld. Ed.]

Unified Conspiracy Theory?

Dear Duncan: I have been reading NEXUS for the best part of five years, and I feel I have had my money's worth of entertainment, stimulation and wonderment...

What I am looking for with each new issue is something like a Grand Unified Conspiracy Theory. All these 'little conspiracies' you are

reporting on don't seem to worry the 'big boys' at all, otherwise you would not be breathing and selling magazines any more. If nothing ever happens to you, then we, your readers and worshippers, could construe this as proof that the stuff you are reporting on has no solid basis in fact...

If, on the other hand, one of your future headlines would read "NEXUS Office Raided by Ugly Men Dressed in Black!", then our faith would be restored and we could feel the tingling of nerves, approaching the newsstand, asking in a hushed voice and with furtive sideways glances for a copy of...NEXUS, then slipping it into a brown paper bag and making sure nobody follows us on the way home.

We want you to bite the bit and start reporting on the mother of all conspiracies...

Helmut S., Coober Pedy, South Australia

[Helmut, if we were 'raided', obviously we would use this to get extra 'mileage'. Perhaps it is for this reason we have not been 'visited' yet? As for the Grand Unified Conspiracy Theory, we're still digging. Every time we peel one layer off the onion, there appears to be another one underneath! Ed.]

Alien Healing Encounter

Dear NEXUS: After reading the piece on alien healing experiences in the last issue [5/06], I thought you might like to hear of a similar experience.

It happened in December 1997. I had injured my back after doing some heavy lifting, and was suffering badly as a result. At the time I was sleeping on a sofa bed on the floor, and getting in and out of bed was particularly painful.

On the night in question I had gone to bed, lying on my side (which was less painful), and had dropped off to sleep.

I awoke later (what time, I don't know) with the feeling there was something behind me doing something to my back. I tried to move but was unable to do so. A feeling of panic came over me as I struggled to see what was behind me. I'm not sure if I managed to turn, or whether the picture came into my head, but I saw behind me a being (I think that is the best word to use, as I don't know what else to call it),

or at least I saw it from the neck upwards. I won't describe it in detail, but it had an insect look about it, and I assume, as I was lying on the floor, that it was about two to three feet tall. Instead of feeling more afraid after seeing this thing, I can remember saying to myself, "Oh that's alright"—then all fear vanished and I went back to sleep.

In the morning when I awoke, I had a memory of getting out of bed, going to the window and watching a small, roundish object, with a row of red light around the bottom, take off from a field about 150 yards away.

Now I could put it all down to a bad dream, having had similar nighttime experiences before, which I tend to file away in the back of my mind until I hear of something similar—which is why I have written this letter.

The next morning, my back was fine; not a twinge. All the pain was gone, and I would like to think it was the strange little creature who made it better.

Yours very sincerely,

C. H., Auckland, New Zealand

The 'Joe' Energy Phenomenon

Duncan: First of all, may I congratulate you on such a superb magazine, a real eye-opener. I have been an avid reader ever since I discovered it by accident at a local newsagent.

One of the subjects that I am particularly interested in is hydrogen power for automotive vehicles, especially as I work for a vehicle manufacturer on automotive engine management systems. 'The Joe Phenomenon' in issue 5/05, and updated in 5/06, was an enlightenment to other hydrogen generators which have appeared in your magazine and I have read about elsewhere, as their energy release just didn't add up. I believe that the Joe Phenomenon is an explanation of where the extra energy comes from.

In connection with the update in issue 5/06, I was horrified to read that a glass hinged-lid jar was used as a cell, especially as pressure build-up was noted with the plastic cell in the main article. Can I just say that there are plastic versions of these jars available, and two of them are sitting on my bench, ready to made up into the said cell when I get some spare time. One is transparent and the other is opaque.

I would be interested in contacting other people who are experimenting with the Joe Phenomenon so that notes can be compared. Maybe you have an idea how this could be achieved.

Keep up the good work.

Roy Hammond, RKHammond@compuserve.com

Fluoride-Coated Frying Pans!

Dear Duncan: The last NEXUS update on fluoride [5/03] was amazing, to say the least. I sent for the copies of the authors' technical research papers, where every one of them stated that fluoride was an extremely dangerous substance. I thought you and your readers might like to know that fluoride is in your frying pan as well.

It was Julia's birthday on Saturday and I thought I would buy one of those new home-bread-making machines. My main concern was that the bread dough would probably be sitting in an aluminium container of some sort and therefore aluminium would be absorbed into the food. And as we don't want any more aluminium, I asked lots of annoying questions to the shopkeeper who assured me that if that was what my problem was—well, "It's coated in Teflon and therefore the aluminium won't be a problem!"

I decided to ring the technical and research departments of Sanyo, Sunbeam and Panasonic to sort out the confusion. Most technical and research divisions could not answer me directly and had to look everything up in books and papers.

But I did discover that Teflon, which is a name owned by DuPont but copied by everyone else, is called PTFE, which means 'polytetra-fluoro-ethylene!' The production manager of Sanyo in Sydney referred to it as "fluoride resin"! The 'poly' and the 'tetra' refer to numbers, which means the main ingredients are fluoride mixed with plastic!

I guess we will making bread by hand after all, but I thought you and your readers might like to know about this. Who would want to cook their food on fluoride-coated cookware?

Regards,

Paul Cadwallader, pjcadz@victnet.net.au

CANADIAN SCIENTISTS FORCED TO APPROVE UNSAFE DRUGS

The Canadian Government's Health Protection Branch is once again the centre of controversy, with six of its scientists charging they have been pressured to approve drugs of questionable safety.

Activists from the Sierra Club and the Council of Canadians held a news conference recently (16 September), to publicise a case about which scientists are under Health Department orders not to talk to the media.

"The department scientists are being forced to approve drugs not safe for animal and human consumption," said Maude Barlow of the Council of Canadians.

She called for a public investigation of the branch, saying drug companies now provide 70 per cent of its financing and have too much influence over the drug-approval process.

Many of the scientists' concerns centre on bovine growth hormone, a genetically engineered drug manufactured by Monsanto, which increases milk production in dairy cattle. The drug is banned in Europe and is the subject of immense controversy on both sides of the Atlantic.

(Source: *LifeSaveIn@aol.com*, 18 September 1998)



SKY-EYE TO BUST KIDNAPPERS

Italian dignitaries who fear being kidnapped are having microprocessor devices planted in their bodies so police can track them down if they are abducted.

The microchips, called Sky-Eyes, were originally developed by Israeli researchers for intelligence use, and are sold by a company called Gen-Etics. They are said to be made of "synthetic and organic fibre", and reportedly run on such a small amount of energy that it can be "borrowed" from the human body. The chip is supposed to be invisible to the naked eye and to X-rays.

The Sky-Eye is said by its promoters to have a margin of error of just 150 metres.

(Sources: *The Telegraph, London*; *SMH Online*; 7 October 1998)

CANADIAN PRISONERS USED AS TEST SUBJECTS

Canadian prisoners were used as human guinea pigs in questionable medical experiments conducted for more than a decade, the *Ottawa Citizen* reports.

An investigation by the *Citizen* and *Southam News* discovered that inmates of federal prisons were commonly used as test subjects throughout the 1960s and into the 1970s. The research was sponsored by drug companies, universities and the federal government, the newspaper reported Saturday (26 Sept.).

The tests involved hundreds of male and female prisoners. They were given unproven pharmaceuticals, were subjects in sensory-deprivation research, and were involved in pain studies employing electric shocks.

Recent revelations of similar experiments performed in the United States two decades ago were met with public furore.

(Source: *Vancouver Sun*, 27 Sept. 1998)

US PRESSURE ON UK TO GROW ENGINEERED CROPS

Bill Clinton has personally intervened with Tony Blair to try to stop Britain from halting the controversial production of genetically engineered/modified foods.

The US President telephoned the Prime Minister during the (northern) summer to try to persuade him that genetically modified (GM) crops, worth millions to the US economy, would not be bad for Britain.

Sources close to the Government say that the US President has been pressing Blair to support commercial production of GM crops in Britain, despite growing consumer opposition.

Consumer and environmental groups including *English Nature*, the Government's wildlife advisers, want the Government to introduce a moratorium on growing such crops commercially in the UK for at least three years.

France and Austria have temporarily banned the growth of genetically modified food until more is known about its effects on the environment.

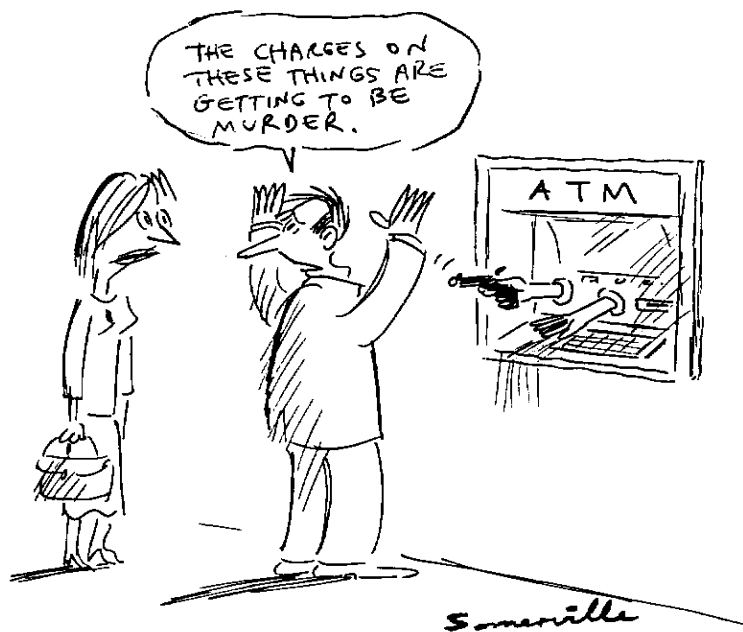

Clinton's intervention has outraged British MPs and environmentalists who accuse the US President of intruding in a sensitive domestic matter.

The Clinton administration has close links with Monsanto, the powerful biotechnology conglomerate which develops seeds for GM crops.

Monsanto, which made a profit of almost US\$300 million (£177 million) in 1997, is one of five companies spearheading Clinton's welfare-to-work program, and the President singled out the biotech company for praise during his 1997 State of the Nation address.

During the 1996 election, Monsanto was among those donating thousands of dollars in 'soft money' (legal funds which are not included in the ban on corporate donations) to the Clinton camp.

Meanwhile, in a package of measures designed to leave the door open to the powerful biotechnology industry and at the same time reassure consumers, the British Government announced in late October that no commercial growing of GM crops would be allowed before autumn 1999.

This is far short of the three-year moratorium called for by environment, health and consumer groups. The government will allow six farms to grow GM crops on a commercial basis under strict ecological monitoring to establish the effects of wide-scale planting. However, the government is to ban commercial growing of insect-resistant crops for three years.

(Sources: The Independent on Sunday, London, 6 September 1998; The Guardian Weekly, w/e 1 November 1998)

EU DROPS INVESTIGATION INTO 'ECHELON' SPY NETWORK

The European Parliament has swept aside concerns about alleged surveillance and spying activities conducted in the region by the US Government, according to a Green Party representative of the body quoted on Monday (5 October).

Specifically, the EU allegedly scuttled parliamentary debate late last September concerning the *Echelon* surveillance system. *Echelon* is a near-mythical intelligence network operated in part by the National Security Agency.

"The whole discussion was completely brushed over," said Patricia McKenna, a Green Party member of the European Parliament.

The US Government has refused even to

acknowledge *Echelon's* existence. But since 1988, investigative journalists and privacy watchdogs have uncovered details of a secret, powerful system that can allegedly intercept any and all communications within Europe.

The Green Party believes the resolution to defer its decision on *Echelon*, pending further investigation, was influenced by pressure from the US Government which has tried to keep the system secret.

Echelon is said to be principally operated by the US National Security Agency and its UK equivalent, the Government Communications Headquarters. It reportedly also relies on cooperation with other intelligence agencies in Canada, Australia and New Zealand.

(Source: by Niall McKay, *Wired News*, www.wired.com, 10 October 1998)

CRASHED ISRAELI JET CARRIED TOXIC CARGO

Among the substances now known to have burned in the inferno of the Israeli El Al cargo jet, which crashed into an Amsterdam apartment block in 1992, were 800 pounds of depleted uranium and three of the four chemicals needed to make sarin, including about 50 gallons of dimethyl methylphosphonate (DMMP).

As sirens wailed and flashing lights swept the fiery wreckage of the 12-storey block, the 'black box' cockpit voice recorder disappeared from the evidence bin where firefighters insist they put it.

Five hours into the rescue effort, after Dutch security police had cleared the crash site of emergency workers and press, men in white hooded firesuits were seen jumping from a heli-

copter into the smouldering rubble and carrying off debris in unmarked trucks. Police videotapes were erased before investigators had a chance to review them, and vital details of the cargo's hazardous contents were kept secret for years, until recently.

The investigation of the disaster, which took at least 43 lives on the ground and four more aboard the Boeing 747 jet, now looks to be either a monumental bungle or a textbook cover-up.

But if Israeli or Dutch officials conspired to hide the full extent of the risks to which those in the crash area were exposed, they overlooked an important source of evidence: the survivors.

Six years after the crash in the densely populated Bijlmermeer district, at least 1,200 residents and rescue workers are complaining of physical and psychological ailments they fear were caused by something carried in the El Al cargo hold.

With the disclosure this month that the jet carried sarin components, passions have flared among sick residents and their baffled doctors. A Dutch parliamentary inquiry has been ordered to try to discover the truth about the disaster.

(Sources: The Guardian Weekly, London, w/e 11 October 1998; Los Angeles Times, www.latimes.com, 13 October 1998)



MOLECULAR MEMORY COULD BE TRANSMITTED BY E-MAIL!

French researcher Jacques Benveniste is set to become the first person in history to win two 'Ig Nobel' prizes when this year's awards are announced at a ceremony at Harvard University (8 October).

Benveniste won his first 'Ig'—awarded annually by Marc Abrahams, editor of *The Annals of Improbable Research*, and a group of scientists—for work claiming to show that antibody solutions retain their biological effectiveness, even when diluted to the point where no trace of the antibody is detectable (*Nature* 333:816, 1988). The water, Benveniste argues, preserves a "memory" of the substance after it is gone.

The second Ig Nobel Prize will be awarded to Benveniste for an extension of this work. Benveniste now claims that a solution's biological activity can be digitally recorded, stored on a computer hard drive, sent over the Internet as an attached document, and transferred to a different water sample at the receiving end (see <http://www.digibio.com>).

"We've demonstrated that you can transmit the biological effect by e-mail between Chicago and Paris," says Benveniste, who heads the Digital Biology Laboratory, in Clamart, France, which is financed by the private company DigiBio SA. "With this approach, you could transfer the activity of a drug by means of standard telecommunications technology."

Benveniste says that he is "happy to receive a second Ig Nobel Prize, because it

shows that those making the awards don't understand anything. People don't give out Nobel prizes without first trying to find out what the recipients are doing. But the people who give out Ig Nobels don't even bother to inquire about the work."

(Source: *Nature*, vol. 395, 8 October 1998)

HEALTH CONCERNS PROMPT CALL TO REDUCE PESTICIDE USE

Nicholas Ashford, Professor of Technology and Policy at Massachusetts Institute of Technology, says he thinks chemicals are the most serious environmental problem facing industrialised countries today.

Professor Ashford, who is also an adviser to the United Nations Environment Program, is known for his work on the theory of multiple chemical sensitivity (MCS). The theory suggests people can become sensitised by exposure to one form of contamination so that they are then liable to be affected by a whole range of other pollutants, including detergents, traffic fumes and tobacco smoke.

Organophosphates (OPs) may be one of the most common initiators of MCS, according to Professor Ashford. OPs are used in sheep dip, shampoos and flea collars and are also used for fumigating public transport vehicles.

Prof. Ashford said, "Pesticides are nerve poisons; they damage the brain and they are also known to be endocrine disruptors [synthetic chemicals which interfere with naturally produced hormones]."

Professor Ashford believes that the huge rise in pesticide use over the last half-century could explain many illnesses, ranging from skin rashes and breathing problems to cancers and birth defects. He wants to see an immediate reduction in pesticide use until the effects are better understood, and is pressing for the formation of an EU environment unit to study the problem.

(Source: by Alex Kirby, *BBC Online Environment Correspondent*, 10 Oct 1998)

PULP FRICTION: THE ECOLOGIST vs MONSANTO

The *Ecologist*, the flagship of the green movement in the UK for the past 30 years, has become involved in a row with its printers after an edition of the magazine was pulped.

The journal had used the edition to attack transnational Monsanto's biotechnology and genetic engineering practices, including the so-called Terminator Technology (see article this issue). But the *Ecologist's* printers of 29 years—Penwells of Saltash, Cornwall—destroyed the 14,000-copy print run without notice. The printers refused to comment on their decision, but it is understood that the company was afraid of laying itself open to a libel action.

Daniel Verakis, UK spokesman for Monsanto, admitted that although he knew that the issue of the *Ecologist* was a special one on biotechnology, Monsanto had nothing to do with influencing the printers to pulp the magazine.

(Source: *Guardian Weekly*, London, w/e 4 October 1998)

SANITY CLAUSE FOR VETTING BRITISH SPOOKS

Britain's spies are to be vetted by psychologists to assess whether they can be entrusted with national secrets. The move reflects growing concern about mentally unstable agents.

Under proposals from the House of Commons security watchdog, members of MI6, MI5 and other agencies would be forced to undergo regular psychological tests to spot potential personality disorders.

The House of Commons Intelligence and Security Committee is also considering more exacting staff scrutiny and "more stringent controls on appointments to particularly sensitive posts".

Harold Macmillan once said that anyone who spent more than 10 years in the world of spies must be either weird or mad.

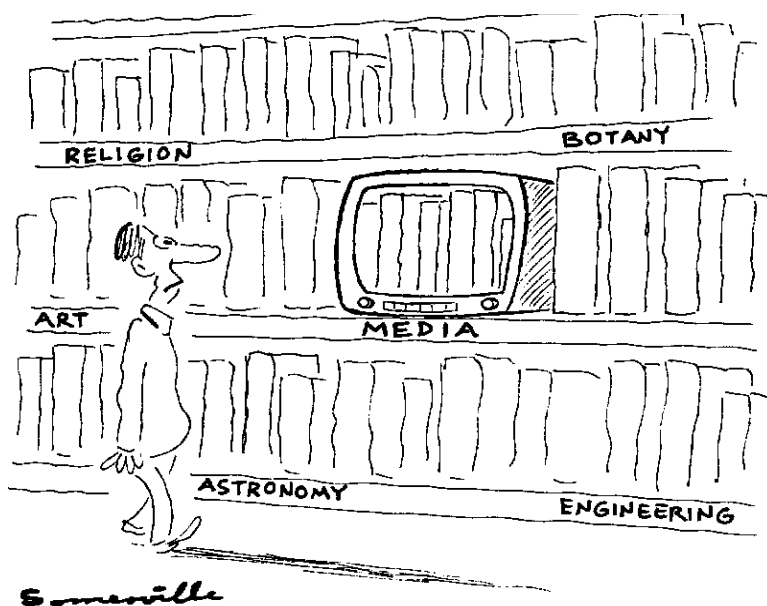

History is full of examples. The first chief of MI6, Sir Mansfield Cumming, wore a gold-rimmed monocle, wrote only in green ink and trundled around his office on a child's scooter. Kim Philby, the most successful double agent of the post-war era, was described by a colleague as "a schizophrenic with a supreme talent for deception". The defector George Blake, imprisoned in 1961 for spying on behalf of the Soviets, admitted he often looked in the mirror and wondered who he was.

The problems are even worse in the Central Intelligence Agency (CIA) if Jeanine Brookner, its first woman station chief, is to be believed. In court four years ago, she claimed that CIA officers "would either be busy sleeping with each other's wives, drunk, taking drugs, fiddling their expenses, seeing the agency psychiatrist or perhaps doing them all at once".

(Source: by David Connett and Jonathan Calvert, *The Observer*, London, 26 October 1998)

FROM A FIELD NEAR YOU... ESCAPE OF THE TRANSGENES!

Heightening environmentalists' fears about the dangers of genetic engineering, a weed altered by scientists to resist a herbicide has also developed a far greater ability to pollinate other plants and pass on its traits.

Joy Bergelson, a professor of ecology and evolution at the University of Chicago, said the findings show that genetic engineering can substantially increase the chances of 'transgene escape'—the spread of certain traits from one plant to another. Her co-authored study has been published in the journal *Nature* (vol. 395, 3 Sept 1998).

Charles Margulis of Greenpeace said the results confirm fears that genetically engineering cotton and soybeans to survive spraying with herbicides to make weed-control easier, will force farmers to spray heavier doses of herbicides or use types that are less environmentally safe.

"It's just another chink in the armour of the industry, which keeps saying environmentalists' claims of health concerns just aren't justified," Margulis said.

Scientists have already recognised that when a genetically engineered crop grows near a weed relative, the gene-engineered trait will eventually transfer to the weed.

(Source: by Jeff Barnard, *Associated Press*, 2 September 1998)

PHARMACEUTICAL DRUGS POLLUTE OUR WATER

A new class of water pollutant has been discovered during the past six years. Pharmaceutical drugs (including antibiotics, hormones, strong painkillers, tranquillisers, and cancer chemotherapy chemicals) given to people and to domestic animals, are being measured in surface water, in groundwater and in drinking water at the tap. Large quantities of drugs are excreted by humans and domestic animals, and are distributed into the environment by flushing toilets and by spreading manure and sewage sludge onto and into soil.

German scientists report that anywhere from 30 to 60 drugs can be measured in a typical water sample—if anyone takes the time to do the proper analyses (*Science News* 153[12]:187-189, 21 Mar. 1998). The concentrations of some drugs in water are comparable to the low parts-per-billion (ppb) levels at which pesticides are typically found. Some people find this reassuring, but others are asking: "What is the long-term effect of drinking, day after day, a dilute cocktail of pesticides, antibiotics, painkillers, tranquillisers and chemotherapy agents?" Of course, no one knows the answer to such a question. It is simply beyond the capabilities of science to sort out the many chemical interactions that could occur in such a complex chemical soup.

The first study that detected drugs in sewage took place at the Big Blue River sewage treatment plant in Kansas City, USA, in 1976. The problem was duly recorded in scientific literature (*Life Sciences* 20[2]:337-341, 15 Jan. 1997) and then ignored for 15 years. In 1992, researchers in Germany were looking for herbicides in water when they kept noticing a chemical they couldn't identify. It turned out to be clofibrac acid (CA), a drug used by many people in large quantities to reduce cholesterol levels in the blood. Clofibrac acid is a close chemical cousin of the popular weed-killer, 2,4-D.

Since 1992, researchers in Germany, Denmark and Sweden have been measuring levels of CA and other drugs in rivers, lakes and the North Sea. To everyone's surprise, it turns out that the entire North Sea contains measurable quantities of clofibrac acid. Based on the volume of the sea, which is 12.7 quadrillion gallons, and the average concentration of CA, which is 1 to 2 parts per trillion (ppt), researchers estimate that the North Sea contains 48 to 96 tons of clofibrac acid (*Environmental Science and Technology* 32[1]:188-192, 1998).

The Danube River in Germany and the Po River in Italy also contain measurable quantities of clofibrac acid. Of more immediate concern to humans is the finding that tap water in all parts of the city of Berlin contains clofibrac acid at concentrations between 10 and 165 ppt. The water supplies of other major cities remain to be tested.

Drugs are designed to have particular characteristics. For example, 30 per cent of the drugs manufactured between 1992 and 1995 were lipophilic (*Chemosphere* 36[2]:357-393, 1998). This means that the drugs tend to dissolve in fat but not in water, and this gives them the ability to pass through cell membranes and act inside cells. Unfortunately it also means that, once they are excreted into the environment, they enter food chains and concentrate as they move upward into larger predators. Many drugs are also designed to be persistent so that they can retain their chemical structure long enough to do their therapeutic work. Unfortunately, after they are excreted, such drugs also tend to persist in the environment. A landfill used by the Jackson Naval Air Station in Florida contaminated groundwater with a plume of chemicals that has been moving slowly underground for more than 20 years. The drugs pentobarbital (a barbiturate), meprobamate (a tranquilliser sold as Equanil and Miltown) and phenisuximide (an anticonvulsant) are still measurable in that groundwater plume (*Chemosphere*, *ibid.*)

When a human or an animal is given a drug, anywhere from 50 to 90 per cent of it is excreted unchanged. The remainder is excreted in the form of metabolites—chemicals produced as by-products of the body's interaction with the drug. Researchers report that some of the metabolites are more lipophilic and more persistent than the original drugs from which they were derived (*Chemosphere*, *ibid.*)

Another problem resulting from drugs in the environment is bacteria developing resistance to antibiotics. The general problem of antibiotic-resistant bacteria has been recognised for more than a decade. Antibiotics are only useful to humans so long as bacteria do not become resistant to their effects. Bacteria exposed to antibiotics in sewage sludge or water have an opportunity to develop resistance.

(Source: by Peter Montague, *Rachel's Environment & Health Weekly*, no. 614, 3 September 1998; PO Box 5036, Annapolis, MD 21403, USA; tel (410) 263 1584; fax (410) 263 8944; e-mail, erf@rachel.org; for transcript, see www.monitor.net/rachel/)

CENTRAL BANKING AND THE PRIVATE CONTROL OF MONEY

By creating and controlling the money supply, the so-called Money Changers have maintained control over governments and citizens for millennia.

Part 1 of 2

Extracted from the book of the video
**THE MONEY MASTERS:
How International Bankers
Gained Control of America**

Published & revised in 1998 by
Royalty Production Company
PO Box 114, Piedmont OK 73078, USA
www.themoneymasters.com

1. THE US FEDERAL RESERVE

There was a time when to ask someone for whom he worked was considered somewhat insulting, as it implied he was an incompetent, incapable of gainful self-employment. But now, property ownership (net wealth) is not a general feature of our society, as it largely was until the Great Depression. Rather, net debt and complete dependence on a precarious wage or salary at the will of others is the general condition.

Since the exercise of freedom often includes using material objects such as books, food, clothing, shelter, arms, transport, etc., the choice and possession of which requires some wealth, we are forced to admit that the general condition of Americans is one of increasing dependence and limitations on freedom.

Since the turn of the century, there has occurred throughout the world a major increase in debt and a major decline in the freedom of individuals and states to conduct their own affairs. To restore a condition of widespread, modest wealth is therefore essential to regaining and preserving our freedom.

Why are we over our heads in debt? Why can't the politicians bring debt under control? Why are so many people (often, both parents) working at low-paying, dead-end jobs and still making do with less? What's the future of the American economy and way of life? Are we headed into an economic crash of unprecedented proportions?

Larry Bates was a bank president for eleven years. As a member of the Tennessee House of Representatives, he chaired the Committee on Banking and Commerce. He's also a former professor of economics and the author of the best-selling book, *The New Economic Disorder*. He has this to say about our future prospects:

I can tell you right now that there is going to be a crash of unprecedented proportions—a crash like we have never seen before in this country. The greatest shock of this decade is that more people are about to lose more money than at any time before in history, but the second greatest shock will be the incredible amount of money a relatively small group of people will make at the same time. You see, in periods of economic upheaval, in periods of economic crisis, wealth is not destroyed—it is merely transferred.

Former US presidential candidate Charles Collins is a lawyer and a banker who has owned banks and served as a bank director. He believes we'll never get out of debt because the Federal Reserve ('the Fed') is in control of our money. To quote Collins:

Right now, it's perpetuated by the Federal Reserve making us borrow the money from them, at interest, to pay the interest that's already accumulated. So we cannot get out of debt the way we're going now.

Economist Henry Pasquet is a tenured instructor in economics. He agrees that the end is near for the US economy:

No, not when you are adding roughly a billion dollars a day. We just can't go on. We had less than one trillion dollars of national debt in 1980; now it's \$5 trillion—five times greater in fifteen years. It just doesn't take a genius to realize that this just can't go on forever.

The problem is that the US has one of the worst monetary systems ever devised: a central bank that operates independently of the government, which, with other private banks,

creates all of our money with a parallel amount of interest-bearing debt. That's why we can never get out of debt. And that's why a deep Depression is a certainty for most US citizens, whether caused suddenly in a severe economic crash or gradually through continued relentless inflation. The Fed is creating it to enrich its private stockholders—just as it deliberately created the Great Depression of the 1930s.

The Federal Reserve headquarters is in Washington, DC. It sits on a very impressive address on Constitution Avenue, right across from the Lincoln Memorial. But is it 'Federal'? Is it really part of the United States Government?

Well, what we are about to show you is that there is nothing 'Federal' about the Federal Reserve—and there are no reserves. The name is a deception created before the Federal Reserve Act was passed in 1913 to make Americans think that America's new central bank operates in the public interest.

The truth is that the Fed is a private (or, at best, quasi-public) bank owned by private national banks, which are the stockholders, and run for their private profit.

As economist Henry Pasquet noted:

That's exactly correct; the Fed is a privately owned, for-profit corporation which has no reserves—at least no reserves to back up the Federal Reserve notes which are our common currency.

The Federal Reserve Act was railroaded through a carefully prepared Congressional Conference Committee meeting, scheduled during the unlikely hours of 1.30 am to 4.30 am (when most members were sleeping) on Monday 22 December 1913, at which 20 to 40 substantial differences in the House and Senate versions were supposedly described, deliberated upon, debated, reconciled and voted upon in a near-miraculous four-and-a-half to nine minutes per item, at that late hour.

At 4.30 am, a prepared report of this Committee was handed to the printers. Senator Bristow of Kansas, the Republican leader, stated on the *Congressional Record* that the Conference Committee had met without notifying them, and that Republicans were not present and were given no opportunity either to read or sign the Conference Committee report. The Conference report is normally read on the Senate floor. The Republicans did not even see the report. Some senators stated on the floor of the Senate that they had no knowledge of the contents of the Bill.

At 6.02 pm on 23 December, when many members had already left the Capitol for the Christmas holiday, the very same day that the Bill was hurried through the House and Senate, President Woodrow Wilson signed the Federal Reserve Act of 1913 into law.

The Act transferred control of the money supply of the United States from Congress to a private banking elite. It is not surprising that a bill granting a few national bankers a private money monopoly was passed in such a corrupted manner.

As author Anthony C. Sutton noted:

The Federal Reserve System is a legal private monopoly of the money supply, operated for the benefit of the few under the guise of protecting and promoting the public intent.

If there's any doubt whether the Federal Reserve is a part of the

US Government, check your local telephone book. It's not listed in the 'government' blue pages. It is correctly listed in the 'business' white pages, right next to Federal Express, another private company. But more directly, US courts have ruled that the Fed is a special form of private corporation.

Let's take a look at the Fed shareholders. According to researcher Eric Samuelson, as of November 1997 the Federal Reserve Bank of New York (which completely dominates the other 11 branches through stock ownership, control and influence, having the only permanent voting seat on the Federal Open Market Committee and handling all open market bond transactions), has 19,752,655 shares outstanding and is majority-owned by two banks: Chase Manhattan bank (now merged with Chemical Bank), with 6,389,445 shares or 32.35 per cent; and Citibank, NA, with 4,051,851 shares or 20.51 per cent. Together, those two banks own 10,441,295 shares or 52.86 per cent—which is majority control.

While majority ownership conclusively demonstrates effective control, it is not critical to control—which is often exercised in large, publicly traded corporations by blocks of as little as 25 per cent, and even two per cent when the other owners hold smaller blocks.

One of the most outspoken critics of the Fed in Congress was Louis T. McFadden (R-PA), the Chairman of the House Banking and Currency Committee during the Great Depression years. In 1932 he said:

But more directly, US courts have ruled that the Fed is a special form of private corporation.

We have in this country one of the most corrupt institutions the world has ever known. I refer to the Federal Reserve Board... This evil institution has impoverished...the people of the United States...and has practically bankrupted our government. It has done this through...the corrupt practices of the moneyed vultures who control it.

Senator Barry Goldwater was a frequent critic of the Fed:

Most Americans have no real understanding of the operation of the international money-lenders... The accounts of the Federal Reserve System have never been audited. It operates outside the control of Congress and...manipulates the credit of the United States.

What one has to understand is that from the day the Constitution was adopted, right up to today, the folks who profit from privately owned central banks like the Fed, or, as President Madison called them, 'the Money Changers', have fought a running battle for control over who gets to issue America's money.

Why is *who* issues the money so important? Think of money as just another commodity. If you have a monopoly on a commodity that everyone needs, everyone wants and nobody has enough of, there are lots of ways to make a profit and also exert tremendous political influence. That's what this battle is all about.

Throughout the history of the United States, the money power has gone back and forth between Congress and some sort of privately owned central bank. The American people fought off four privately owned central banks before succumbing to the first stage of a fifth privately owned central bank during a time of national weakness: the Civil War.

The founding fathers knew the perils of a privately owned cen-

tral bank. First of all, they had seen how the privately owned British central bank, the Bank of England, had run up the British national debt to such an extent that Parliament had been forced to place unfair taxes on the American colonies. In fact, Ben Franklin claimed that this was the real cause of the American Revolution.

Most of the founding fathers realised the potential dangers of banking and feared bankers' accumulation of wealth and power.

Thomas Jefferson put it this way:

I sincerely believe that banking institutions are more dangerous to our liberties than standing armies. Already they have raised up a money aristocracy that has set the government at defiance. The issuing power should be taken from the banks and restored to the people to whom it properly belongs.

Jefferson's succinct statement is in fact the solution to most of our economic problems today.

James Madison, the main author of the Constitution, agreed. It is interesting that he called those behind the central bank scheme 'the Money Changers'. Madison strongly criticised their actions:

History records that the Money Changers have used every form of abuse, intrigue, deceit and violent means possible to maintain their control over governments by controlling money and its issuance.

The battle over who gets to issue our money has been the pivotal issue through the history of the United States. Wars have been fought over it. Depressions have been caused to acquire it. And yet, after World War I this battle was rarely mentioned in newspapers or history books.

Media Complicity

By World War I, the Money Changers with their dominant wealth had seized control of most of the US press.

In a 1912 Senate Privileges and Elections Committee hearing, a letter was introduced to the Committee, written by Representative Joseph Sibley (PA), a Rockefeller agent in Congress, to John D. Archbold, a Standard Oil employee of Rockefeller. It read in part:

An efficient literary bureau is needed, not for a day or a crisis but a permanent healthy control of the Associated Press and kindred avenues. It will cost money but will be cheapest in the end.

John Swinton, the former Chief of Staff of the *New York Times*, called by his peers "the Dean of his profession", was asked in 1953 to give a toast before the New York Press Club. He responded with the following statement:

There is no such thing as an independent press in America, if we except that of little country towns. You know this and I know it. Not a man among you dares to utter his honest opinion. Were you to utter it, you know beforehand that it would never appear in print.

I am paid one hundred and fifty dollars a week so that I may keep my honest opinion out of the newspaper for which I write. You, too, are paid similar salaries for similar services. Were I to permit that a single edition of my newspaper contained an honest opinion, my occupation—like Othello's—would be gone

in less than twenty-four hours. The man who would be so foolish as to write his honest opinion would soon be on the streets in search of another job.

It is the duty of a New York journalist to lie, to distort, to revile, to toady at the feet of Mammon, and to sell his country and his race for his daily bread—or, what amounts to the same thing, his salary.

We are the tools and the vassals of the rich behind the scenes. We are marionettes. These men pull the strings and we dance. Our time, our talents, our lives, our capacities are all the property of these men. We are intellectual prostitutes.

(Quoted by T. St John Gaffney in *Breaking The Silence*, p. 4.)

That was the US press in 1953. It is the mass media of America today. Press control and, later, electronic media (radio and TV) control were seized in carefully planned steps, yielding the present situation in which all major mass media and the critically important major reporting services, which are the source of most news stories, are controlled by the Money Changers.

Representative Callaway discussed some of this press control in the *Congressional Record* (vol. 54, 9 February 1917, p. 2947):

In March 1915, the J. P. Morgan interests, the steel, shipbuilding and powder interests and their subsidiary organizations, got together 12 men high up in the newspaper world and employed them to select the most influential newspapers in the United States, and sufficient number of them to control generally the policy of the daily press...

They found it was only necessary to purchase the control of 25 of the greatest papers... An agreement was reached; the policy of the papers was bought, to be paid for by the month; an editor was furnished for each paper to properly supervise and edit informa-

tion regarding the questions of preparedness, militarism, financial policies, and other things of national and international nature considered vital to the interests of the purchasers.

A few years ago, three-quarters of the majority stockholders of ABC, CBS, NBC and CNN were banks—such as Chase Manhattan Corp., Citibank, Morgan Guaranty Trust and Bank of America. Ten such corporations controlled 59 magazines (including *Time* and *Newsweek*), 58 newspapers (including the *New York Times*, the *Washington Post* and the *Wall Street Journal*), and various motion-picture companies, giving the major Wall Street banks virtually total ownership of the mass media with few exceptions (such as Disney's purchase of ABC).

Only 50 cities in America now have more than one daily paper, and they are often owned by the same group. Only about 25 per cent of the nation's 1,500 daily papers are independently owned. This concentration has been rapidly accelerating in recent years and ownership is nearly monolithic now, reflecting the identical control described above. Of course, much care is taken to fool the public with the appearance of competition by maintaining different corporate logos, anchorpersons and other trivia, projecting a sense of objectivity that belies the uniform underlying bank ownership and editorial control. This accounts for the total blackout on news coverage and investigative reporting on banker control of the country.

The battle over who gets to issue our money has been the pivotal issue through the history...

Wars have been fought over it. Depressions have been caused to acquire it.

Nevertheless, throughout US history, the battle over who gets the power to issue our money has raged. In fact, it has changed hands back and forth eight times since 1694, in five transition periods which may aptly be described as 'Bank Wars' (or, more precisely, 'Private Central Bank vs American People Wars'), yet this fact has virtually vanished from public view for over three generations behind a smoke screen emitted by Fed cheerleaders in the media.

Until we stop talking about 'deficits' and 'government spending' and start talking about who creates and controls how much money we have, it's just a shell game, a complete and utter deception. It won't matter if we pass an iron-clad amendment to the Constitution mandating a balanced budget. Our situation is only going to get worse until we root out the cause at its source.

Our leaders and politicians, those few who are not part of the problem, need to understand what is happening and how, as well as what solutions exist. The government must take back the power to issue our money without debt.

Issuing our own debt-free money is not a radical solution. It's the same solution proposed at different points in US history by men like Benjamin Franklin, Thomas Jefferson, Andrew Jackson, Martin van Buren, Abraham Lincoln, William Jennings Bryan, Henry Ford, Thomas Edison, and numerous congressmen and economists.

Though the Federal Reserve is now one of the two most powerful central banks in the world, it was not the first. So where did this idea come from? To really understand the magnitude of the problem, we have to travel across the Atlantic.

2. THE MONEY CHANGERS IN JERUSALEM

Just who are these Money Changers to whom James Madison referred? The Bible tells us that, 2,000 years ago, Jesus Christ twice drove the Money Changers from the Temple in Jerusalem. Apart from when the Temple Guards were forced to the ground in the Garden of Gethsemane, these were the only times Jesus used physical violence. What were Money Changers doing in the Temple?

When Jews came to Jerusalem to pay their Temple tax, they could only pay it with a special coin, the half-shekel of the sanctuary. This was a half-ounce of pure silver, about the size of a quarter. It was the only coin around at that time which was pure silver and of assured weight, without the image of a pagan Emperor. Therefore, to Jews, the half-shekel was the only coin acceptable to God. But these coins were not plentiful. The Money Changers had cornered the market on them; then they raised the price—just as with any other monopolised commodity—to whatever the market would bear.

In other words, the Money Changers were making exorbitant profits because they held a virtual monopoly on money. The Jews had to pay whatever they demanded. To Jesus, this injustice violated the sanctity of God's house.

3. MONEY-CHANGING IN THE ROMAN EMPIRE

But the money-changing scam did not originate in Jesus' day. Two hundred years before Christ, Rome was having trouble with its Money Changers.

Two early Roman emperors had tried to diminish the power of

the Money Changers by reforming usury laws and limiting land ownership to 500 acres. Both were assassinated. In 48 BC, Julius Caesar took back from the Money Changers the power to coin money and then minted coins for the benefit of all. With this new, plentiful supply of money, he built great public works. By making money plentiful, Caesar won the love of the common people. But the Money Changers hated him. Some believe this was an important factor in Caesar's assassination.

One thing is for sure: with the death of Caesar came the demise of plentiful money in Rome. Taxes increased, as did corruption. Eventually the Roman money supply was reduced by 90 per cent. As a result, the common people lost their lands and homes—just as has happened and will happen again in America to the few who still own their own land and homes.

4. THE GOLDSMITHS OF MEDIAEVAL ENGLAND

The Chinese were the first to use paper money, known as 'flying money' (a kind of banker's draft), in AD 618–907. In about AD 1000, private Chinese merchants in Sichuan province issued paper money known as *jiao zi*. Due to fraud, the right to issue paper money was taken over in 1024 by the Song dynasty which then issued the first government paper money.

About that same time, Money Changers—those who exchange, create and manipulate the quantity of money—were active in mediaeval England. In fact, they were so active that, acting together, they could manipulate the English economy. These were not bankers *per se*. The Money Changers generally were the goldsmiths. They were the first bankers because they started keeping other people's gold for safekeeping in their safe rooms, or vaults.

The first 'paper' money in Western Europe was merely a receipt for gold left with the goldsmiths, made from rag paper. As the ditty goes:

Rags make paper; paper makes money; money makes banks; banks make loans; loans make beggars; beggars make rags.

Paper money caught on because it was more convenient and safer to carry than a lot of heavy gold and silver coins. As a convenience, to avoid unnecessary trips to the goldsmiths, depositors began endorsing these gold deposit receipts to others, by their signature.

Over time, to simplify the process, the receipts were made out to the bearer, rather than to the individual depositor, making them readily transferable without the need for a signature. This, however, broke the tie to any identifiable deposit of gold.

Eventually, goldsmiths noticed that only a small fraction of the depositors or bearers ever came in and demanded their gold at any one time. Goldsmiths started cheating on the system. They began by secretly lending out some of the gold that had been entrusted to them for safekeeping, and keeping the interest earned on this lending. Then the goldsmiths discovered that they could print more money (i.e., paper gold-deposit certificates) than they had gold, and usually no one would be any the wiser. Next, they discovered they could lend out this extra paper money and collect interest on it. This was the birth of 'fractional reserve lending'—that is, lending out more money than you have reserves on deposit. Obviously it was fraud, often specifically outlawed once understood.

Until we stop talking about 'deficits' and 'government spending' and start talking about who creates and controls how much money we have, it's just a shell game, a complete and utter deception.

The goldsmiths began with relatively modest cheating, lending out in gold deposit certificates only two or three times the amount of gold than they actually had in their safe rooms. But they soon grew more confident and greedy, lending out four, five and even ten times more gold certificates than they had gold on deposit.

So, for example, if \$1,000 in gold were deposited with them, they could lend out about \$10,000 in paper money and charge interest on it, and no one would discover the deception. By this means, goldsmiths gradually accumulated more and more wealth and used this wealth to accumulate more and more gold.

It was this abuse of trust—a fraud—which, after being accepted as standard practice, evolved into modern deposit banking. It is still a fraud, coupled with an unjust and unreasonable delegation of a sovereign government function—money creation—to private banks.

Today, this practice of lending out more money than there are reserves is known as 'fractional reserve banking'. In other words, banks have on hand only a small fraction of the reserves needed to honour their obligations. Should all their account-holders come in and demand cash, the banks would run out before even three per cent had been paid. That is why banks always live in dreadful fear of 'bank runs'. This is the fundamental cause of the inherent instability in banking, stock markets and national economies.

The banks in the United States are allowed to lend out at least ten times more money than they actually have. That's why they do so well on charging, let's say, 8 per cent interest. But it's not really 8 per cent per year which

is their interest income on money the government issues; it's 80 per cent. That's why bank buildings are always the largest in town. Every bank is, *de facto*, a private mint (over 10,000 in the US), issuing money as loans, for nothing, at no cost to them except whatever interest they pay depositors.

Rather than issue more gold certificates than they have gold, modern bankers simply make more loans than they have currency (cash). They do this by making book entries, creating loans to borrowers out of thin air (or, rather, ink).

To give a modern example, a \$10,000 bond purchase by the Fed on the open market results in a \$10,000 deposit to the bond-seller's bank account. Under a 10 per cent (i.e., fractional) reserve requirement, the bank need keep only \$1,000 in reserve and may lend out \$9,000. This \$9,000 is ordinarily deposited by the borrower in either the same bank or in other banks, which then must keep 10 per cent (\$900) in reserve but may lend out the other \$8,100. This \$8,100 is in turn deposited in banks which must keep 10 per cent (\$810) in reserve but then may lend out \$7,290, and so on. Carried to the theoretical limits, the initial \$10,000 created by the Fed is deposited in numerous banks in the banking system, giving rise (in roughly 20 repeated stages) to an expansion of \$90,000 in new loans in addition to the \$10,000 in reserves.

In other words, the banking system, collectively, multiplies the \$10,000 created by the Fed by a factor of ten. However, less than one per cent of the banks create over 75 per cent of this money. In other words, a handful of the largest Wall Street banks creates money as loans, literally by the hundred-billion, charging interest on these loans and leaving crumbs for the rest of the banks to cre-

ate. But because those crumbs represent billions, too, the lesser bankers rarely grumble. Rather, with rare exceptions, they, too, support this corrupt system.

In actual practice, due to numerous exceptions to the 10 per cent reserve requirement, the banking system multiplies the Fed's money creation by several magnitudes over ten times (e.g., the Fed requires only three per cent reserves on deposits under approx. \$50 million, and no reserves on Eurodollars and non-personal time deposits).

To return to the goldsmiths... They also discovered that extra profits could be made by 'rowing' the economy between easy money and tight money. When they made money easier to borrow, then the amount of money in circulation expanded. Money was plentiful, and people took out more loans to expand their businesses. But then the goldsmiths would tighten the money supply and make loans more difficult to obtain.

What would happen? Just what happens today. A certain percentage of people could not repay their previous loans and could not take out new loans to repay the old ones; therefore they went bankrupt and had to sell their assets to the goldsmiths or at auction for 'pennies on the dollar'.

The same thing is still going on today, only now we call this up-and-down rowing of the economy the 'business cycle', or, more recently in the stock markets, 'corrections'.

5. TALLY STICKS

King Henry I, son of William the Conqueror, ascended the English throne in AD 1100. At that time, long before the invention of the printing

press, taxes were generally paid in kind, i.e., in goods, based on the productive capacity of the land under the care of the taxpaying serf or lesser noble. To record production, mediaeval European scribes used a crude accounting device: notches on sticks, or 'tallies' (from the Latin *talea*, meaning 'twig' or 'stake'). Tally sticks worked better than faulty memory or notches on barn doors, as were sometimes used.

To prevent alteration or counterfeiting, the sticks were cut in half lengthwise, leaving one half of the notches on each piece—one of which was given to the taxpayer, and could be compared for accuracy by reuniting the pieces. Henry adopted this method of tax-record-keeping in England.

Over time, the role of tally sticks evolved and expanded. By the time of Henry II, taxes were paid twice a year. The first payment, made at Easter, was evidenced by giving the taxpayer a tally stick notched to indicate partial payment received, with the same lengthwise split to record, for both parties, the payment made. These were presented at Michaelmas with the balance of taxes then due.

It takes only a little imagination to arrive at the next step: for tallies to be issued by the government in advance of taxes being paid, in order to raise funds in emergencies or financial straits. The recipients would accept such tallies for goods sold at a profit or for coin at a discount, and then would use them later, at Easter or Michaelmas, for payment of the taxes. Thus, tallies took on some of the same functions as coin: they served as money for the payment of taxes.

After 1694, the government issued 'paper tallies' as paper evidence of debt (i.e. government borrowing) in anticipation of the

So, for example, if \$1,000 in gold were deposited with them, they could lend out about \$10,000 in paper money and charge interest on it, and no one would discover the deception.

collection of future taxes. Paper could be made easily negotiable, which made paper tallies the full equivalent of the paper banknote money issued by the Bank of England beginning in 1694. By 1697, tallies, banknotes and bankbills all began to circulate freely as interchangeable forms of money. Wooden-stick tallies continued to be used until 1826. Doubtless, ways were found to make them circulate at discounts, too, like the paper tallies.

One particular tally stick was quite valuable. It represented £25,000. One of the original stockholders in the Bank of England purchased his original shares with such a stick. In other words, he bought shares in the world's richest and most powerful corporation, with a stick of wood.

It's ironic that after its formation in 1694, the Bank of England attacked the tally stick system because it was money issued outside the control of the Money Changers.

Why would people accept sticks of wood for money? That's a great question. Throughout history, people have traded anything they thought had value and used that for money. You see, the secret is that money is only what people agree on to use as money. What's our paper money today? It's really just paper.

But here's the trick. King Henry VIII ordered that tally sticks be used to evidence tax payments received by the government. This built in the demand for tallies and eventually made them circulate and be accepted as money. And they worked well. In fact, no other money worked for so long as in the British Empire.

In the 1500s, King Henry VIII relaxed the laws concerning usury, and the Money Changers wasted no time reasserting themselves. They made their gold and silver money plentiful for a few decades. But when Queen Mary took the throne and tightened the usury laws again, the Money Changers renewed the hoarding of gold and silver coin, forcing the economy to plummet.

When Queen Elizabeth I, Mary's half-sister, took the throne in 1558, she was determined to regain control over English money. Her solution was to issue gold and silver coins from the public treasury and thus take away control over the money supply from the Money Changers.

Although control over money was not the only cause of the English Revolution in 1642 (religious differences also fuelled the conflict), monetary policy played a major role. Financed by the Money Changers, Oliver Cromwell finally overthrew King Charles I (Stuart), purged Parliament and put the King to death. The Money Changers were immediately allowed to consolidate their financial power.

The result was that for the next fifty years the Money Changers plunged Great Britain into a series of costly wars. In the centre of London they took over a square mile of property, known as 'the City'. Today, this semi-sovereign area is still one of the two predominant financial centres of the world (with Wall Street, New York City). It is not under the jurisdiction of the London police, but has its own private force of 2,000 men.

Conflicts with the Stuart Kings led the Money Changers in England to combine with those in the Netherlands (which already had a central bank established by the Money Changers in Amsterdam in 1609) to finance the invasion of William of Orange who overthrew the legitimate Stuarts in 1688. England was to trade masters: an unpopular King James II for a hidden cabal of

Money Changers pulling the strings of their usurper, King William III ('King Billy'), from behind the scenes.

This symbiotic relationship between the Money Changers and the higher British aristocracy continues to this day. The monarch has no real power but serves as a useful shield for the Money Changers who rule the City—dominated by the banking House of Rothschild.

In its 20 June 1934 issue, *New Britain* magazine of London cited a devastating assertion by former British Prime Minister David Lloyd George, that "Britain is the slave of an international financial bloc". It also quoted these words written by Lord Bryce: "Democracy has no more persistent and insidious foe than the money powers" and pointed out that "questions regarding the Bank of England, its conduct and its objects, are not allowed by the Speaker" (of the House of Commons).

6. THE BANK OF ENGLAND

By the end of the 1600s, England was in financial ruin. Fifty years of more or less continuous wars with France, and sometimes the Netherlands had exhausted her. Frantic government officials met with the Money Changers to beg for the loans necessary to pursue their political purposes. The price was high: a government-sanctioned, privately owned central bank which could issue money—created out of nothing—as loans.

The Bank of England was to be the modern world's first privately owned, national central bank in a powerful country, though earlier deposit banks had existed in Venice from 1361, in Amsterdam from 1609, and in Sweden from 1661—where the first banknotes in Europe were issued that same year.

Although it was deceptively called the Bank of England to make the general population think it was part of the government, it was not. Like any other private corporation, the Bank of England sold shares to get started. The investors, whose names were never revealed, were supposed to put up one and a quarter million (British pounds) in gold coin to buy their shares in the Bank. But only £750,000 pounds was ever received.

Despite that, the Bank of England was duly chartered in 1694 and started out in the business of lending out several times the money it supposedly had in reserves, all at interest. In exchange, the new bank would lend British politicians as much as they wanted. The debt was secured by direct taxation of the British people.

So, legalisation of the Bank of England amounted to nothing less than legalised counterfeiting of a national currency for private gain. Unfortunately, nearly every nation now has a privately controlled central bank, the local Money Changers using the Bank of England as the basic model.

Such is the power of these central banks that they soon take total control over a nation's economy. It soon amounts to nothing but a plutocracy, rule by the rich, and the bankers soon come to be the dominant super-rich class. It is like putting control of the Army in the hands of the Mafia. The danger of tyranny is extreme. Yes, we need a central monetary authority—but one owned and controlled by the government, not by bankers for their private profit.

Such is the power of these central banks that they soon take total control over a nation's economy. It soon amounts to nothing but a plutocracy, rule by the rich...

Continued on page 79

THE OILING OF AMERICA

Modern-day diets high in hydrogenated vegetable oils instead of traditional animal fats are implicated in causing a significant increase in heart disease and cancer.

Part 1 of 2

by Mary G. Enig, PhD
MGEnig@aol.com
&
Sally Fallon
SAFallon@aol.com
© 1998

In 1954, a young researcher from Russia, named David Kritchevsky, published a paper describing the effects of feeding cholesterol to rabbits.¹ Cholesterol added to vegetarian rabbit chow caused the formation of atheromas—plaques that block arteries and contribute to heart disease. Cholesterol is a heavyweight molecule—an alcohol or a sterol—found only in animal foods such as meat, cheese, eggs and butter.

In the same year, according to the American Oil Chemists Society, Kritchevsky published a paper describing the beneficial effects of polyunsaturated fatty acids for lowering cholesterol levels.² (Polyunsaturated fatty acids are the kind of fats found in large amounts in highly liquid vegetable oils made from corn, soybeans, safflower seeds and sunflower seeds. Mono-unsaturated fatty acids are found in large amounts in olive oil, palm oil and lard; saturated fatty acids are found in large amounts in fats and oils that are solid at room temperature, e.g., butter, tallow and coconut oil.)

Scientists of the period were grappling with a new threat to public health: a steep rise in heart disease. While turn-of-the-century mortality statistics are unreliable, they consistently indicate that heart disease caused no more than 10 per cent of all deaths—considerably less than infectious diseases such as pneumonia and tuberculosis. By 1950, coronary heart disease (CHD) was the leading source of mortality in the United States, causing more than 30 per cent of all deaths. The greatest increase came under the rubric of myocardial infarction (MI)—a massive blood clot leading to obstruction of a coronary artery and consequent death to the heart muscle. MI was almost non-existent in 1910 and caused no more than 3,000 deaths per year in 1930. By 1960, there were at least 500,000 MI deaths per year in the US. What lifestyle changes had caused this increase?

One change was a decrease in infectious disease following the decline of the horse as a means of transport, the installation of more sanitary water supplies and the advent of better housing, all of which allowed more people to reach adulthood and the heart attack age. The other was a dietary change.

Since the early part of the century when the US Department of Agriculture (USDA) had begun to keep track of food 'disappearance' data (the amount of various foods going into the food supply), a number of researchers had noticed a change in the kind of fats Americans were eating. Butter consumption was declining, while the use of vegetable oils, especially oils that had been hardened to resemble butter by a process called 'hydrogenation', was increasing dramatically. By 1950, butter consumption had dropped from 18 pounds per person per year to just over 10 pounds. Margarine filled in the gap, rising from about 2 pounds per person at the turn of the century to about 8 pounds. Consumption of vegetable shortening—used in crackers and baked goods—remained relatively steady at about 12 pounds per person per year, but vegetable oil consumption had more than tripled from just under 3 pounds per person per year to more than 10 pounds.³

The statistics pointed to one obvious conclusion: Americans should eat the traditional foods—including meat, eggs, butter and cheese—that nourished their ancestors, and avoid the newfangled, vegetable-oil-based foods that were flooding the grocers' shelves.

The Kritchevsky articles attracted immediate attention because they lent support to another theory—one that militated against the consumption of meat and dairy products. This was the lipid hypothesis: namely, that saturated fat and cholesterol from animal sources raise cholesterol levels in the blood, leading to deposition of cholesterol and fatty material as pathogenic plaques in the arteries.

Kritchevsky's rabbit trials were actually a repeat of studies carried out four decades earlier in St Petersburg, in which rabbits fed saturated fats and cholesterol developed fatty

deposits in their skin and other tissues—and in their arteries. By showing that polyunsaturated oils from vegetable sources lowered serum cholesterol at least temporarily in humans, Kritchevsky appeared to show that the findings from the animal trials were relevant to the CHD problem, that the lipid hypothesis was a valid explanation for the new epidemic, and that, by reducing animal products in their diets, Americans could avoid heart disease.

In the years that followed, a number of population studies demonstrated that the animal model—especially one derived from vegetarian animals—was not a valid approach for the problem of heart disease in human omnivores.

A 1955 report on artery plaques in soldiers killed during the Korean War showed little difference in the number and severity of plaques between American soldiers and those of Japanese natives—75 per cent versus 65 per cent—even though the Japanese diet at the time was lower in animal products and fat.⁴ A 1957 study of the largely vegetarian Bantu found that they had as much atheroma—occlusions or plaque build-up in the arteries—as other races from South Africa who ate more meat.⁵ A 1959 report noted that Jamaican Blacks showed a degree of atherosclerosis comparable to that found in the United States, although they suffered from lower rates of heart disease.⁶ A 1960 report noted that the severity of atherosclerotic lesions in Japan approached that of the United States.⁷ The 1968 International Atherosclerosis Project, in which over 22,000 corpses in 14 nations were cut open and examined for plaques in the arteries, showed the same degree of atheroma in all parts of the world—in populations that suffered from a great deal of heart disease, and in populations that had very little or none at all.⁸

All of these studies pointed to the fact that the thickening of the arterial walls is a natural, unavoidable process. The lipid hypothesis did not hold up to these population studies, nor did it explain the tendency toward fatal clots that caused myocardial infarction.

In 1956, an American Heart Association (AHA) fund-raiser was aired on all three major networks. The Master of Ceremonies interviewed, among others, Irving Page and Jeremiah Stamler of the AHA and researcher Ancel Keys. Panellists presented the lipid hypothesis as the cause of the heart disease epidemic and launched the Prudent Diet, one in which corn oil, margarine, chicken and cold cereal replaced butter, lard, beef and eggs.

The television campaign was not an unqualified success because one of the panellists, Dr Dudley White, disputed his colleagues at the AHA. Dr White noted that heart disease in the form of myocardial infarction was non-existent in 1900 when egg consumption was three times what it was in 1956 and when corn oil was unavailable. When pressed to support the Prudent Diet, Dr White replied: "See here, I began my practice as a cardiologist in 1921 and I never saw an MI patient until 1928. Back in the MI-free days before 1920, the fats were butter and lard, and I think that we would all benefit from the kind of diet that we had at a time when no one had ever heard the word *corn* oil."

But the lipid hypothesis had already gained enough momentum to keep it rolling, in spite of Dr White's nationally televised plea for common sense in matters of diet and in spite of the contradictory studies that were showing up in the scientific literature.

In 1957, Dr Norman Jolliffe, Director of the Nutrition Bureau of the New York Health Department, initiated the Anti-Coronary Club in which selected businessmen, ranging in age from 40 to 59 years, were placed on the Prudent Diet. Club members used corn oil and margarine instead of butter; cold breakfast cereals instead of eggs and chicken; and fish instead of beef. Anti-Coronary Club members were to be compared with a 'matched' group of the same age who ate eggs for breakfast and had meat three times a day. Dr Jolliffe, an overweight diabetic confined to a wheelchair, was confident that the Prudent Diet would save lives, including his own.

In the same year, the food industry initiated advertising campaigns that touted the health benefits of their products: "Low in fat" or "Made with vegetable oils". A typical ad read, "Wheaties may help you live longer". Wesson recommended its cooking oil "for your heart's sake". An ad in the *Journal of the American Medical Association (JAMA)* described Wesson oil as a "cholesterol depressant". Mazola advertisements assured the public that "science finds corn oil important to your health". Medical journal ads recommended Fleishmann's unsalted margarine for patients with high blood pressure.

In his syndicated column, Dr Frederick Stare, head of Harvard University's Nutrition Department, encouraged the consumption of corn oil—up to one cup a day. In a promotional piece specifically for Procter & Gamble's Puritan oil, he cited two experiments and one clinical trial as showing that high blood cholesterol is

associated with CHD. However, both experiments had nothing to do with CHD, and the clinical trial did not find that reducing blood cholesterol had any effect on CHD events. Later, Dr William Castelli, director of the Framingham Study, was one of several specialists to endorse Puritan. Dr Antonio Gotto, Jr, former AHA president, sent practising physicians a letter promoting Puritan oil—printed on Baylor College of Medicine, The De Bakey Heart Center letterhead.⁹

The irony of Gotto's letter is that De Bakey, the famous heart surgeon, co-authored a 1964 study involving 1,700 patients, which also showed no definite correlation between serum cholesterol levels and the nature and extent of coronary artery disease.¹⁰ In other words, those with low cholesterol levels were just as likely to have blocked arteries as those with high cholesterol levels.

But while studies like DeBakey's mouldered in the basements of university libraries, the vegetable oil campaign took on increased bravado and audacity.

The American Medical Association (AMA) at first opposed the commercialisation of the lipid hypothesis and warned that "the anti-fat, anti-cholesterol fad is not just foolish and futile...it also carries some risk".

The American Heart Association, however, was committed. In 1961, the AHA published its first dietary guidelines aimed at the public. The authors—Irving Page, Ancel Keys, Jeremiah Stamler and Frederick Stare—called for the substitution of polyunsaturateds for saturated fat, even though Keys, Stare and Page had all previously noted in published papers that the increase in CHD was paralleled by increasing consumption of vegetable oils. In fact, in a 1956 paper, Keys had suggested that the increasing use of hydrogenated vegetable oils might be the underlying cause of the CHD epidemic.¹¹

The American Medical Association (AMA) at first opposed the commercialisation of the lipid hypothesis and warned that "the anti-fat, anti-cholesterol fad is not just foolish and futile... it also carries some risk".

Stamler showed up again in 1966 as an author of *Your Heart Has Nine Lives*, a little self-help book advocating the substitution of vegetable oils for butter and other so-called 'artery-clogging' saturated fats. The book was sponsored by the makers of Mazola corn oil and margarine. Stamler did not believe that lack of evidence should deter Americans from changing their eating habits. The evidence, he stated, was "compelling enough to call for altering some habits even before the final proof is nailed down...the definitive proof that middle-aged men who reduce their blood cholesterol will actually have far fewer heart attacks waits upon diet studies now in progress". His version of the Prudent Diet called for substituting low-fat milk products such as skim milk and low-fat cheeses for cream, butter and whole cheeses, reducing egg consumption and cutting the fat off red meats. Heart disease, he lectured, was a disease of rich countries, striking rich people who ate rich food, including 'hard' fats like butter.

It was in the same year, 1966, that the results of Dr Jolliffe's Anti-Coronary Club experiment were published in *JAMA*.¹² Those on the Prudent Diet of corn oil, margarine, fish, chicken and cold cereal had an average serum cholesterol of 220, compared to 250 in the meat-and-potatoes control group. However, the study authors were obliged to note that there were eight deaths from heart disease among Dr Jolliffe's Prudent Diet group, and none among those who ate meat three times a day. Dr Jolliffe was dead by this time. He succumbed in 1961 to a vascular thrombosis, although the obituaries listed the cause of death as "complications from diabetes". The compelling "proof" that Stamler and others were sure would vindicate wholesale tampering with American eating habits had not yet been "nailed down".

The problem, said the insiders promoting the lipid hypothesis, was that the numbers involved in the Anti-Coronary Club experiment were too small. Dr Irving Page urged a National Diet-Heart Study involving one million men, in which the results of the Prudent Diet could be compared on a large scale with those on a diet high in meat and fat. With great media attention, the National Heart, Lung and Blood Institute organised the stocking of food warehouses in six major cities, where men on the Prudent Diet could get tasty polyunsaturated doughnuts and other fabricated food items free of charge.

But a pilot study, involving 2,000 men, resulted in exactly the same number of deaths in both the Prudent Diet group and control group. A brief report in *Circulation* (March 1968) stated that the study was a milestone "in mass environmental experimentation" that would have "an important effect on the food industry and the attitude of the public toward its eating habits". But the million-man Diet-Heart Study was abandoned in utter silence "for reasons of cost". Its chairman, Dr Irving Page, died of a heart attack.

Most animal fats—like butter, lard and tallow—have a large proportion of saturated fatty acids. Saturated fats are straight chains of carbon and hydrogen that pack together easily so that they are relatively solid at room temperature. Oils from seeds are composed mostly of polyunsaturated fatty acids. These molecules have kinks in them at the point of the unsaturated double bond. They do not pack together easily and therefore tend to be liquid at room temperature.

Judging from both food data and turn-of-the-century cookbooks, the American diet in 1900 was a rich one, with at least 35 to 40 per cent of calories coming from fats, mostly dairy fats in the form of butter, cream, whole milk, and also eggs. Salad dressing recipes usually called for egg yolks or cream; only occasionally for olive oil. Lard or tallow served for frying. Rich dishes like head cheese and scrapple contributed additional saturated fats during an era when cancer and heart disease were rare. Butter substitutes made up only a small portion of the American diet, and these margarines were blended from coconut oil, animal tallow and lard—all rich in natural saturates.

The technology by which liquid vegetable oils could be hardened to make margarine was first discovered by a French chemist named Sabatier. He found that a nickel catalyst would cause the hydrogenation (the addition of hydrogen to unsaturated bonds to make them saturated) of ethylene gas to ethane. Subsequently, the British chemist Norman developed the first application of hydrogenation to food oils and took out a patent.

In 1909, Procter & Gamble acquired the US rights to a British patent on making liquid vegetable oils solid at room temperature. The process was used on both cotton-seed oil and lard to give

"better physical properties", to create shortenings that did not melt as easily on hot days.

The hydrogenation process transforms unsaturated oils into straight 'packable' molecules by rearranging the hydrogen atoms at the double bonds. In nature, most double bonds occur in the *cis* configuration, i.e., with both hydrogen atoms on the same side of the carbon chain at the point of the double bond. It is the *cis* isomers of fatty acids that have a bend or kink at the double bond, preventing them from packing together easily. Hydrogenation creates *trans*

double bonds by moving one hydrogen atom across to the other side of the carbon chain at the point of the double bond. In effect, the two hydrogen atoms then balance each other and the fatty acid straightens, creating a packable 'plastic' fat with a much higher melting temperature.

Although *trans* fatty acids are technically unsaturated, they are configured in such a way that the benefits of unsaturation are lost. The presence of several unpaired electrons presented by contiguous hydrogen atoms in their *cis* form allows many vital chemical reactions to occur at the site of the double bond. When one hydrogen atom is moved to the other side of the fatty acid molecule during hydrogenation, the ability of living cells to make reactions at the site is compromised or altogether lost. *Trans* fatty acids are sufficiently similar to natural fats that the body readily incorporates them into the cell membrane; once there, their altered chemical structure creates havoc with thousands of necessary chemical reactions—everything from energy provision to prostaglandin production.

After the Second World War, 'improvements' made it possible to plasticise highly unsaturated oils from corn and soybeans. New catalysts allowed processors to 'selectively hydrogenate' the kinds of fatty acids found in soy and canola oils—those with three double bonds. Called 'partial hydrogenation', this new method allowed processors to replace cotton-seed oil with more unsaturated corn and soybean oils in margarines and shortenings. This spurred a meteoric rise in soybean production from virtually

In fact, in a 1956 paper, Keys had suggested that the increasing use of hydrogenated vegetable oils might be the underlying cause of the CHD epidemic.

nothing in 1900 to 70 million tons in 1970, surpassing corn production. Today, soy oil dominates the market and is used in almost 80 per cent of all hydrogenated oils.

The particular mix of fatty acids in soy oil results in shortenings containing about 40 per cent *trans* fats—an increase of about 5 per cent over cotton-seed oil and 15 per cent over corn oil. Canola oil, processed from a hybrid form of rape-seed, is particularly rich in fatty acids containing three double bonds and can contain as much as 50 per cent *trans* fats. *Trans* fats of a particularly problematic type are also formed during the process of deodorising canola oil, yet they are not indicated on labels for canola oil.

Certain forms of *trans* fatty acids occur naturally in dairy fats. *Trans* vaccenic acid makes up about four per cent of the fatty acids in butter. It is an interim product which the ruminant animal then converts to conjugated linoleic acid, a highly beneficial anti-carcinogenic component of animal fat. Humans seem to utilise the small amounts of *trans* vaccenic acid in butter fat without ill effects.

However, most of the *trans* isomers in modern hydrogenated fats are new to the human physiology. By the early 1970s, a number of researchers had expressed concern about their presence in the American diet, noting that the increasing use of hydrogenated fats had paralleled the increase in both heart disease and cancer.

The unstated solution was one that could be easily presented to the public: eat natural, traditional fats; avoid newfangled foods made from vegetable oils; use butter, not margarine.

But medical research and public consciousness took a different tack—one that accelerated the decline of traditional foods like meat, eggs and butter, and fuelled continued dramatic increases in vegetable oil consumption.

Although the AHA had committed itself to the lipid hypothesis and the unproven theory that polyunsaturated oils afforded protection against heart disease, concerns about hydrogenated vegetable oils were sufficiently great to warrant the inclusion of the following statement in the organisation's 1968 Diet-Heart statement: "Partial hydrogenation of polyunsaturated fats results in the formation of *trans* forms which are less effective than *cis,cis* forms in lowering cholesterol concentrations. It should be noted that many currently available shortenings and margarines are partially hydrogenated and may contain little polyunsaturated fat of the natural *cis,cis* form."

While 150,000 copies of the statement were printed, they were never distributed. The shortening industry objected strongly, and a researcher named Fred Mattson of Procter & Gamble convinced Campbell Moses, medical director of the AHA, to remove it.¹³ The final recommendations for the public contained three major points: restrict calories; substitute polyunsaturates for saturates; reduce cholesterol in the diet.

Other organisations fell in behind the AHA in pushing vegetable oils instead of animal fats. By the early 1970s, the National Heart, Lung and Blood Institute, the AMA, the American Dietetic Association and the National Academy of Sciences had all endorsed the lipid hypothesis and the avoidance of animal fats for those Americans in the 'at risk' category.

Since Kritchevsky's early studies, many other trials had shown that serum cholesterol can be lowered by increasing ingestion of polyunsaturates. The physiological explanation for this is that when excess polyunsaturates are built into the cell membranes, resulting in reduced structural integrity or 'limpness', cholesterol is sequestered from the blood into the cell membranes to give them 'stiffness'. The problem was that there was no proof that lowering serum cholesterol levels could stave off CHD.

That did not prevent the American Heart Association calling for "modified and ordinary foods" useful for the purpose of facilitating dietary changes to newfangled oils away from traditional fats. These foods, said the AHA literature, should be made available to the consumer, "...reasonably priced and easily identified by appropriate labeling. Any existing legal and regulatory barriers to the marketing of such foods should be removed."

The man who made it possible to remove any "existing legal and regulatory barriers" was Peter Barton Hutt, a food lawyer for the prestigious Washington, DC, law firm of Covington and Burling. Hutt once stated: "Food law is the most wonderful field of law that you can possibly enter." After representing the edible oil industry, he temporarily left his law firm to become general counsel for the US Food and Drug Administration (FDA) in 1971.

But medical research and public consciousness took a different tack—one that accelerated the decline of traditional foods like meat, eggs and butter, and fuelled continued dramatic increases in vegetable oil consumption.

The regulatory barrier to foods useful to the purpose of changing American consumption patterns was the Food, Drug and Cosmetic Act of 1938, which stated: "...there are certain traditional foods that everyone knows, such as bread, milk and cheese, and that when consumers buy these foods, they should get the foods that they are expecting... [and] if a food resembles a standardized food but does not comply with the standard, that food must be labeled as an 'imitation'."

The 1938 Food, Drug and Cosmetic Act was signed into law partly in response to consumer concerns about the adulteration of ordinary foodstuffs. Chief among the products with a tradition of suffering competition from imitation products were fats and oils.

In his book, *Life on the Mississippi*, Mark Twain reports on a conversation overheard between a New Orleans cotton-seed oil purveyor and a Cincinnati margarine drummer. New Orleans boasts of selling deodorised cotton-seed oil as olive oil in bottles with European labels. "We turn out the whole thing—clean from the word go—in our factory in New Orleans... We are doing a ripping trade, too." The man from Cincinnati reports that his factories are turning out oleomargarine by the thousands of tons, an imitation that "you can't tell from butter". He gloats at the thought of market domination. "You are going to see the day, pretty soon, when you won't find an ounce of butter to bless yourself with, in any hotel in the Mississippi and Ohio valleys, outside of the biggest cities... And we can sell it so dirt cheap that the whole country has got to take it ... butter don't stand any show—there ain't any chance for competition. Butter's had its day—and from this out, butter goes to the wall. There's more money in oleomargarine than—why, you can't imagine the business we do."

In the tradition of Mark Twain's riverboat hucksters, Peter Barton Hutt guided the FDA through the legal and congressional hoops to the establishment in 1973 of the FDA 'imitation' policy

which attempted to provide for "advances in food technology" and give "manufacturers relief from the dilemma of either complying with an outdated standard or having to label their new products as 'imitation'... [since] ...such products are not necessarily inferior to the traditional foods for which they may be substituted". Hutt considered the word 'imitation' to be oversimplified, inaccurate and "potentially misleading to consumers". The new regulations defined 'inferiority' as any reduction in content of an essential nutrient that is present at a level of two per cent or more of the US Recommended Daily Allowance (RDA). The new 'imitation' policy meant that imitation sour cream, made with vegetable oil and fillers like guar gum and carrageenan, need not be labelled 'imitation' as long as artificial vitamins were added to bring macronutrient levels up to the same amounts as those in real sour cream. Coffee creamers, imitation egg mixes, processed cheeses and imitation whipped cream no longer required the 'imitation' label, but could be sold as real and beneficial foods, low in cholesterol and rich in polyunsaturates.

These new regulations were adopted without the consent of Congress, continuing the trend instituted under Nixon in which the White House would use the FDA to promote certain social agendas through government food policies. They had the effect of increasing the lobbying clout of special-interest groups such as the edible oil industry, and short-circuiting public participation in the regulatory process. It allowed food processing innovations, regarded as 'technological improvements' by manufacturers, to enter the marketplace without the onus of economic fraud that might be engendered by greater consumer awareness and congressional supervision. They ushered in the era of ersatz foodstuffs, convenient counterfeit products—weary, stale, flat and immensely profitable.

Congress did not voice any objection to this usurpation of its powers, but entered the contest on the side of the lipid hypothesis. The Senate Select Committee on Nutrition and Human Needs, chaired by George McGovern during the years 1973 to 1977, actively promoted the use of vegetable oils.

"Dietary Goals for the United States", published by the committee, cited USDA data on fat consumption and stated categorically that "the overconsumption of fat, generally, and saturated fat in particular...have been related to six of the ten leading causes of death" in the United States. The report urged the American populace to reduce overall fat intake and to substitute polyunsaturates for saturated fat from animal sources—margarine and corn oil for butter, lard and tallow.

Opposing testimony included a moving letter (buried in the voluminous report) by Dr Fred Kummerow of the University of Illinois, urging a return to traditional whole foods and warning against the use of soft drinks. In the early 1970s, Kummerow had shown that *trans* fatty acids caused increased rates of heart disease in pigs. A private endowment allowed him to continue his research, but government-funded agencies such as the National Institutes of Health refused to give him further grants.

One study that was known to McGovern Committee members, but not mentioned in its final report, compared calves fed saturated fat from tallow and lard with calves fed unsaturated fat from soybean oil. The calves fed tallow and lard did indeed show high-

er plasma cholesterol levels than the soybean-oil-fed calves; fat-streaking was found in their aortas, and atherosclerosis was also enhanced. But the calves fed soybean oil showed a decline in calcium and magnesium levels in the blood, possibly due to inefficient absorption. They utilised vitamins and minerals inefficiently, showed poor growth and poor bone development, and had abnormal hearts. More cholesterol per unit of dry matter was found in the aorta, liver, muscle, fat and coronary arteries—a finding which led the investigators to the conclusion that the lower blood cholesterol levels in the soybean-oil-fed calves may be the result of cholesterol being transferred from the blood to other tissues. The calves in the soybean oil group collapsed when forced to move around and they were unaware of their surroundings for short periods. They also had rickets and diarrhoea.

The McGovern Committee report continued dietary trends already in progress: the increased use of vegetable oils, especial-

ly in the form of partially hydrogenated margarines and shortenings. In 1976, the FDA established the GRAS (Generally Recognized As Safe) status for hydrogenated soybean oil. A report prepared by the Life Sciences Research Office of the Federation of American Scientists for Experimental Biology (LSRO-FASEB) concluded: "There is no evidence in the available information on hydrogenated soybean oil that demonstrates or suggests reasonable ground to suspect a hazard to the public when it is used as a direct or indirect food ingredient at levels that

are now current or that might reasonably be expected in the future."

When Mary Enig, a graduate student at the University of Maryland, read the McGovern Committee report, she was puzzled. Enig was familiar with Kummerow's research and she knew that the consumption of animal fats in America was not on the increase. Quite the contrary, the use of animal fats had been declining steadily since the turn of the century.

A report in the *Journal of American Oil Chemists*—which the McGovern Committee did not use—showed that animal fat consumption had declined from 104 grams per person per day in 1909 to 97 grams per day in 1972, while vegetable fat intake had increased from a mere 21 grams to almost 60 grams.¹⁴ Total per-capita fat consumption had increased over the period, but this increase was mostly due to an increase in unsaturated fats from vegetable oils—with 50 per cent of the increase coming from liquid vegetable oils and about 41 per cent from margarines made from vegetable oils.

Enig noted a number of studies that directly contradicted the McGovern Committee's conclusions that "there is...a strong correlation between dietary fat intake and the incidence of breast cancer and colon cancer"—two of the most common cancers in America. Greece, for example, had less than one-fourth the rate of breast cancer compared to Israel, but the same dietary fat intake. Spain had only one-third the breast cancer mortality of France and Italy, but the total dietary fat intake was slightly greater. Puerto Rico, with a high animal fat intake, had a very

Coffee creamers, imitation egg mixes, processed cheeses and imitation whipped cream no longer required the 'imitation' label, but could be sold as real and beneficial foods, low in cholesterol and rich in polyunsaturates.

Continued on page 80

TERMINATOR TECHNOLOGY

The Killing Fields of the Future?

The use of a technique for genetically engineering the death of second-generation seeds may have destructive consequences for ecosystems as well as human health.

by Martha L. Crouch © 1998

Associate Professor of Biology
Indiana University
Bloomington, Indiana, USA
E-mail: crouch@indiana.edu
Website: <http://www.bio.indiana.edu/people/terminator.html>

Genetically modified organisms (GMOs) have become a commercial reality in agriculture. For example, it is estimated that in 1998 over 18 million acres in the United States will be planted in Roundup Ready® soybeans, which were first introduced in 1996 (Horstmeier, 1998). These soybeans are engineered by the Monsanto corporation to contain a bacterial gene that confers tolerance to the herbicide glyphosate, or Roundup®, also made by Monsanto. Only two years after the introduction of Roundup Ready® soybeans, over 30 per cent of the corn and soybeans planted in the United States and close to 50 per cent of the canola planted in Canada have been genetically engineered to be either herbicide or pesticide resistant.

Monsanto and the other companies that have invested heavily in biotechnology in the last two decades are starting to make some money after years of promises without products, and they are aggressively protecting their patented seeds. In the November 1997 issue of the *Farm Journal*, Monsanto ran a full-page advertisement asking farmers to respect the company's property rights:

It takes millions of dollars and years of research to develop the biotech crops that deliver superior value to growers. And future investment in biotech research depends on companies' ability to share in the added value created by these crops. Consider what happens if growers save and replant patented seed. First, there is less incentive for all companies to invest in future technology, such as the development of seeds with traits that produce higher-yielding, higher-value and drought-tolerant crops. In short, these few growers who save and replant patented seed jeopardize the future availability of innovative biotechnology for all growers. And that's not fair to anyone.

In the future, companies and government breeders who genetically engineer crops may not have to ask for such compliance. If the procedure outlined in a recent patent comes to fruition and is widely used, plant variety protection will be biologically built into the plants themselves.

In March 1998, Delta and Pine Land Company (a seed company later to be purchased by Monsanto), in collaboration with the United States Department of Agriculture, was awarded US Patent Number 5,723,765: Control of Plant Gene Expression. Although the patent is broad and covers many applications, one application favoured by the patent's authors is a scheme to engineer crops to kill their own seeds in the second generation, thus making it impossible for farmers to save and replant seeds.

This 'invention' has been dubbed 'Terminator Technology' by the Rural Advancement Foundation International (RAFI), and that group of researchers has analysed some of the technology's serious social, economic and environmental implications (RAFI, 1998). However, many of the consequences of Terminator cannot be fully appreciated without an understanding of the science behind the invention.

In this paper, I outline the steps involved in engineering Terminator Technology into a specific crop. After explaining the process, I then discuss which details might have the devil in them.

Overview of Terminator Technology

To help describe the Terminator procedure, I've confined the explanation to only one of the many possibilities covered by the patent. The example I have chosen is cotton seed, which previously has been genetically engineered with a unique trait: herbicide tolerance. In my discussion, I have assumed that to ensure that descendants of the herbicide-tolerant

seeds are not used without compensation to the seed company, the company has additionally genetically engineered the cotton with Terminator. Although this is a hypothetical case (after all, Terminator cotton is not yet on the market), all the components of the procedure have been shown to function, at least in the text of the patent for Terminator.

Cotton is not often sold as a hybrid seed; thus it is a likely candidate for Terminator protection. By way of contrast, corn is usually planted as a hybrid and thus has some measure of variety protection already. This is because the first generation of a hybrid is genetically fairly uniform and has been bred to have desired characteristics that are not present in either parent alone.

When these hybrids make seeds, however, the second generation is quite variable because of the shuffling of genes that occurs during sexual reproduction. Industrial agriculture requires uniformity because the plants must dovetail with mechanisation. Therefore, industrial farmers who grow corn usually buy new seed every year.

There are several major crops which usually are not grown from hybrid seeds. These include wheat, rice, soybeans and cotton. Farmers often save the seeds from these crops, and may not go back to the seed company for several years—or longer, in some parts of the world—to purchase a new variety.

It would be a big boost to seed-company profits if people who now grow non-hybrid crops had to buy new seed every year. This may have been the major incentive for developing the Terminator Technology.

There likely were other reasons for developing Terminator. One reason may relate to the way in which Terminator's effect differs from hybridisation.

When Terminator is used, the second generation is killed. With hybridisation, the second generation is variable but alive, and any genes present in the hybrid will be present in the second generation, although in unpredictable combinations. Therefore, a plant

breeder who wanted to use the genetic material from the hybrid in his or her own breeding program could retrieve it from these plants. With Terminator, the special genes, such as the herbicide tolerance of my example, would not be easily available for use by competitors.

Another reason sometimes cited for using Terminator in combination with a genetically engineered variety is to keep the GMOs from 'escaping' into the environment. Many critics of biotechnology cite problems with releasing GMOs into the wild, noting that their effects on ecosystems and their members would be difficult to predict (Rissler and Mellon, 1996). Having all of the second-generation seeds die would circumvent this problem altogether.

General Description of Terminator Action in Cotton

In the cotton example, the goal is to develop a variety of cotton that will grow normally until the crop is almost mature. Then, and only then, a toxin will be produced in the (seed) embryos, specifically killing the entire next generation of seeds.

The system has three key components.

1. A gene for a toxin that will kill the seed late in development, but will not kill any other part of the plant.

2. A method for allowing a plant breeder to grow several generations of cotton plants, already genetically engineered to contain the seed-specific toxin gene, without any seeds dying. This is required to produce enough seeds to sell for farmers to plant.

3. A method for activating the engineered seed-specific toxin gene after the farmer plants the seeds, so that the farmer's second generation seeds will be killed.

These three tasks are accomplished by engineering a series of genes which are all transferred permanently to the plant so that they are passed on via the normal reproduction of the plant.

Terminator is a complicated process to understand, so it would be helpful to review beforehand some of the basic information about how genes function during the life cycle of a plant. Readers with a good grasp of molecular biology may want to skip the following section and proceed directly to Details of the Terminator Technology.

When Terminator is used, the second generation is killed.

With hybridisation, the second generation is variable but alive, and any genes present in the hybrid will be present in the second generation...

A Simplified Version of Basic Biological Processes

A plant starts life as a single cell—an egg that has been fertilised by sperm which has been delivered to the egg by the pollen. This first cell divides many times to form the tissues and organs characteristic of the species. The process of going from a single cell to an adult is called 'development'.

As development proceeds, cells become different from each other and change. Cells in the leaf become distinct from cells in the root, for example. Most of the differences can be attributed to changes in the kinds and amounts of proteins made in the cells, because many of the structures in cells are made of proteins, and most of the processes

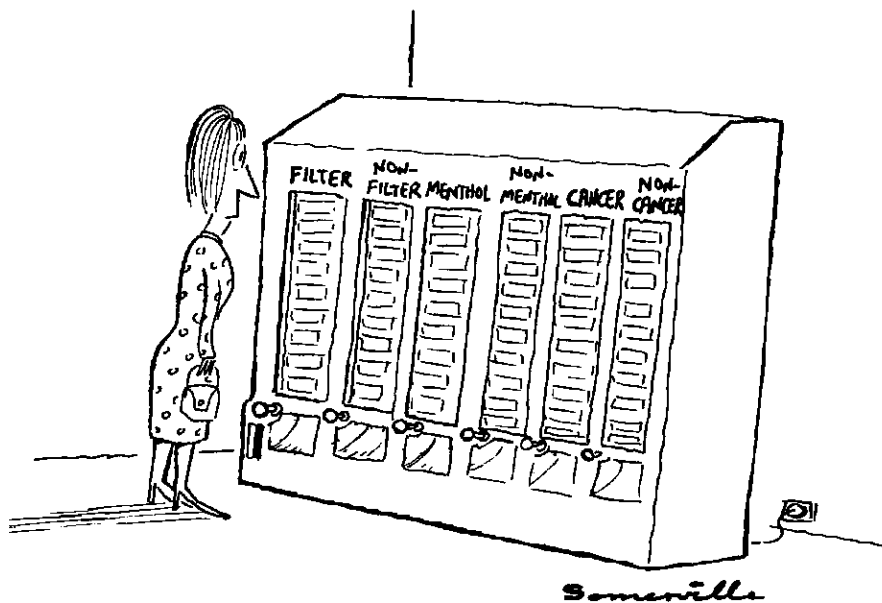

that occur are influenced by enzymes, which are also proteins. Thus, scientists who study development spend a lot of effort describing protein patterns.

By studying which proteins are present in different tissues and organs, biologists have learned that each cell has several thousand different proteins, but most of the proteins are very rare in the cell. A few hundred proteins may be moderately abundant, and a few may be quite abundant. Also, some proteins are found in all kinds of cells and at all times in development, whereas other proteins are only present in a particular tissue or at a specific time. For example, the gluten proteins responsible for the elasticity of bread dough are found only in the seed, and they are present there in very large amounts. In contrast, the enzyme that splits glucose as a first step in releasing energy is found in all living cells, but in fairly small amounts.

Some proteins are made in response to environmental changes, such as increases in temperature, and thus may or may not be present during the life of a particular plant.

The most common way for a cell to control how much of which kinds of proteins are present is to control which genes are functioning (Rosenfeld et al., 1983). Proteins are chains of different amino acids, and the order of amino acids and the length of the chain are unique for each kind of protein. Each unique amino acid sequence is specified by a code on a chromosome in the cell's nucleus. The code is made of DNA.

For the purposes of this discussion, a gene is a piece of DNA that contains the code for a specific protein. Genes are present in specific places along the length of the chromosomes.

It turns out that just about every cell has two full sets of genes (one set of chromosomes from the sperm, and one from the egg) which code for the proteins made in all of the tissues and organs that an individual plant will need during its life cycle. However, only those genes whose proteins are needed in a particular cell will be used by that cell. These are the active genes. The other genes just sit there on the chromosomes, inactive in that cell, but active somewhere else in the plant.

Whether a gene is active or not depends on complex interactions between the DNA and other molecules in the cell. Specifically, a typical gene can be divided into parts. The first part is a stretch of DNA responsible for interacting with the cell or the environment, and is called the 'promoter'. The second part actually contains the code for the order of amino acids in the protein, and is called the 'coding sequence'. When the gene is active, the promoter is interacting with other molecules in a way that allows the coding sequence to direct the synthesis of a specific protein (through a complex set of steps).

Genetic engineering can be defined as the process of manipulating the pattern of proteins in an organism by altering genes. Either new genes are added or existing genes are changed so that they are made at different times or in different amounts.

Because the genetic code is similar in all species, genes taken from a mouse can function in a corn plant, and so on. Also, pro-

moters from one coding sequence can be removed and placed in front of another coding sequence to change when or where the protein is made. For example, when the promoter for casein, the major protein in milk, is removed and put in front of the coding sequence for human growth hormone, it causes human growth hormone to be made in cow's milk, instead of casein. Of course, in order to make human growth hormone in cow's milk, the engineered gene has to be incorporated into the genetic material of the cow. There are many ways to do this, but I will not go into the details here.

The general process of moving genes between species is called 'transformation', and the result is a 'transgenic' organism. Lately, transgenic organisms are being called 'genetically modified organisms' (GMOs).

The Terminator patent offers an ingenious method for keeping the toxin gene from being active until long after the farmers plant their crops.

Details of the Terminator Technology

The key to Terminator is the ability to make a lot of a toxin that will kill cells, and to confine that toxin to seeds. To accomplish this, in the case of our cotton example, the plan is to take the promoter from a gene normally activated late in seed development in cotton and to fuse that promoter to the coding sequence for a protein that will kill an embryo going through the last stages of development.

In the Terminator patent, the authors use a promoter from a cotton LEA (late embryogenesis abundant) gene. This gene is one of the last to be activated. Its protein is not made until the seed is full-sized, has accumulated most of its storage oil and protein, and is drying down in preparation for the dormant period in between leaving the parent plant and germinating in the soil. If the engineered gene has the same pattern of expression, LEA-promoter-directed proteins should be made in high quantities, only in seeds, and late in development.

It is important for the cotton seeds to go through most of their growth before the toxin acts, because the cotton fibre is an outgrowth of the seed coat and is made as the cotton develops. Further, after the cotton fibres are removed (for

human use), the seed is then crushed for oil and protein, both of which are eaten by people and livestock. The cotton crop would be of little use to a farmer if the seeds did not mature normally before dying.

As for a toxin, there are several possibilities discussed in the patent, but the patent authors recommend a ribosome inhibitor protein (RIP) from the plant *Saponaria officinalis*. This protein works in small quantities to stop the synthesis of all proteins. Since cells need proteins for almost everything, they die fairly quickly when they can't make proteins. According to the patent, the RIP is non-toxic to organisms other than plants.

The manipulations of DNA required to engineer a seed-specific promoter/toxin coding sequence gene are done in test-tubes and bacteria, and then the altered gene is put into a cotton plant, using one of several possible well-established methods.

However, this is not all there is to it. If this were all, then as soon as the transgenic plant went through its life cycle and came

around to seed development, that would be the end of the project. There would soon be no viable seeds to sell to farmers.

The Terminator patent offers an ingenious method for keeping the toxin gene from being active until long after the farmers plant their crops. The trick is accomplished by inserting a piece of DNA in between the seed-specific promoter and the toxin coding sequence that blocks it from being used to make protein.

At either end of the blocking DNA are put special DNA pieces that can be recognised by a particular enzyme, such as the enzyme called 'recombinase'. Whenever the recombinase encounters these DNA pieces, the DNA is cut precisely at the outside of each piece, and the cut ends of the DNA fuse together, with the result that the blocking DNA is removed. When this happens, the seed-specific promoter is right next to the toxin coding sequence and is able to function in making the toxin. But this does not happen immediately. Toxin will not be produced until the end of the next round of seed development, because that is when the LEA promoter is active. Thus, after the recombinase enzyme does its work, the plant grows normally from germination, through growth of stems, leaves and roots, all the way through flower formation, pollination and most of seed development. Then, on cue, the seeds die.

All this accomplished, there remains one more problem: how to grow several generations of the genetically engineered variety so that its seed can be multiplied to sell to farmers.

The Terminator patent solves the dilemma by preventing recombinase from acting until just before the farmers plant their seeds. The patent-holders give several possible ways to do this, but concentrate on the following procedure.

They propose putting a recombinase coding sequence next to a promoter that is always active in all cells, at all times, but is repressed. The promoter can be made active again (de-repressed) by a chemical treatment.

Therefore, the seed sellers can treat the seeds right before planting, thus allowing the recombinase to be made then, but not before.

One of the repressible promoter systems they discuss in detail is controlled by the antibiotic, tetracycline. A gene that makes a repressor protein all of the time would be put into the cotton plant, along with a recombinase gene that has a promoter engineered to be inactivated by the repressor protein. Under most conditions, then: the repressor would interact with the recombinase gene; no recombinase would be made; the toxin gene would be blocked; and no toxin would be made, even during seed development when the LEA promoter normally would be active.

To activate the toxin gene, seeds just starting to germinate would be treated with tetracycline just before they are sold to farmers. The tetracycline would interact with the repressor protein, keeping it from interfering with production of recombinase. Recombinase would be made, cutting out the blocking DNA from the toxin gene. The toxin gene would now be capable of making toxin, but would not actually do so until the end of seed development. The next generation would thus be killed.

To accomplish the Terminator effect in cotton, then, three engineered components must all be transferred into a cotton plant's DNA.

1. A toxin gene controlled by a seed-specific promoter, but

blocked by a piece of DNA in between the promoter and the coding sequence.

2. A repressor protein coding sequence with a promoter that is active all of the time.

3. A recombinase coding sequence, controlled by a promoter that would be active at all times, except that it is also regulated by repressor protein which can be overridden with tetracycline.

The actual transfer of genes into the plant is not a very precise operation. Any one of a variety of methods can be used: the genetically engineered DNA can be injected into the nucleus of a cotton cell with a tiny needle; or plant cells can be soaked in the DNA and electrically shocked; or the DNA can be attached to small metal particles and shot into the cells with a gun; or viruses and bacteria can be engineered to infect cells with the DNA.

In all cases, the genetically engineered DNA has to find its way to the nucleus and become incorporated into the plant chromosomes. The number of copies of the inserted genes and their locations on the plant chromosomes are unpredictable, and how well the new genes will function hangs in the balance.

It takes a lot of effort to locate cells that have incorporated DNA in significant amounts and in locations that work. Basically, whole plants have to be regenerated from the cells or tissues that were transformed with the foreign DNA, and then each plant has to be tested for the presence and function of the new genes.

After plants with well-functioning new genes are identified, they are then mated in combinations that result in a line of cotton where both sets of chromosomes, in all of the offspring, have all the components necessary for Terminator to function. These plants are mated together to make a large quantity of seed for sale.

In effect, Terminator Technology gives the seed producer the ability to determine when to set Terminator in motion. Until the recombinase is

made, the cotton plants grow normally. After recombinase is made, the second generation of seeds is killed, thus protecting the patented variety.

Some Problems with Use of Terminator Technology

The patent on this technology is complex. I have described only one of many possible applications of the procedure. Clearly, one cannot determine ahead of time all the possible biological ramifications of implementing the patent. However, potential problems have already been noted (Ho, 1998). I deal with some of them below.

• *Will the Terminator spread to other plants?*

It is likely that Terminator will kill the seeds of neighbouring plants of the same species under certain conditions. However, the effects will be confined to the first generation and will not be able to spread to other generations.

The scenario might go like this... When farmers plant the Terminator seeds, the seeds already will have been treated with tetracycline, and thus the recombinase will have acted and the toxin coding sequence will be next to the seed-specific promoter and will be ready to act when the end of seed development comes around. The seeds will grow into plants which will make pollen. Every pollen grain will carry a ready-to-act toxin gene. If the

It is likely that Terminator will kill the seeds of neighbouring plants of the same species under certain conditions.

Terminator crop is next to a field planted in a normal variety, and pollen is taken by insects or the wind to that field, any eggs fertilised by the Terminator pollen will now have one toxin gene. It will be activated late in that seed's development, and the seed will die. However, it is unlikely that the person growing the normal variety will be able to tell, because the seed will probably look normal. Only when that seed is planted, and doesn't germinate, will the change become apparent.

In most cases, the toxin gene will not be passed on any further because dead plants don't reproduce. However, under certain conditions I will discuss later, it is possible for the toxin gene to be inherited.

In any case, dead seeds, where they occur, would be a serious problem for the farmer whose fields are close to the Terminator crop. How many seeds die will depend on the degree of cross-pollination, which is influenced by the species of plant, the variety of crop, weather conditions, how close the fields are to each other, and so on. If many seeds die, saving seed will be untenable for the adjacent farmer. Even if only a few seeds die, they will contain the toxin and any other proteins engineered into the Terminator-protected variety. These new 'components' may make the seed unusable for certain purposes.

• Will seeds containing the toxin made by Terminator be safe to eat?

In fact, the effects of the toxin on the uses of the seed are a serious question. This issue is discussed in the patent at the end of page 8. There the authors say:

In cotton that would be grown commercially, only selected lethal genes could be used since these proteins could impact the final quality of seeds... If the seed is not a factor in the commercial value of a crop (e.g., in forage crops, ornamentals or plants grown for the floral industry), any lethal gene should be acceptable.

This is dangerously reductionist thinking, because people are not the only organisms that interact with seeds.

In forage crops, for example, all of the forage is not always harvested before seeds are mature, depending on conditions. How will a particular toxin affect birds, insects, fungi and bacteria that eat or infect the seeds? If a forage crop with toxin-laden seeds is left in the field and the seeds come into contact with the soil, how will that affect the ecology of soil organisms? These are important questions because a variety of specific organisms are necessary for the healthy growth of plants.

Further, a floral or ornamental crop with Terminator may happen to grow near a related crop where the seeds are used; but if pollination occurs, the seeds will contain toxin without that farmer knowing. The toxin could end up in products without anyone's knowledge. For example, an ornamental sunflower could spread Terminator to an oil-seed variety, and then the toxin could end up in edible oil or in sunflower seed meal.

Other potential problems with making novel toxins in edible seeds have to do with allergenicity. The RIP toxin described earlier may not be directly poisonous to animals but may cause aller-

gic reactions. If the seeds are being mixed with the general food supply, it will be difficult to trace this sort of effect.

• Will dead seeds have different properties than living seeds?

Although Terminator is supposed to kill seeds very late in development, it is not known what other effects, if any, Terminator may have. Will the dead seeds be more or less easy to store? Perhaps they will respond differently to changes in humidity or to infection with bacteria and fungi.

If dead seeds do behave differently, even a few 'bad apples may spoil the barrel', and the problem of partial killing of neighbours' crops may be even more of an issue.

There also may be nutritional changes in seeds that are killed late in development. Although most of their oils and proteins are present, it is possible that seeds will start to deteriorate or will lack some minor component that is important.

The functional properties of specific molecules in foods, for example, are just beginning to be appreciated and are likely to play important roles in preventing diseases. These possibilities require further study.

• Will use of an antibiotic to treat seeds before planting be a problem?

If seed companies do indeed use tetracycline to set the cascade of toxin-gene activation in motion, then they will have to soak a very large amount of seed in the antibiotic. Basically, every seed planted by the farmer will have to be so treated. How many pounds of cotton seed or wheat seed are needed to plant an acre, and how many acres will be planted?

In fact, I am having trouble visualising exactly how this will work, because the seeds must be treated with tetracycline after they have matured completely (so that the toxin won't be made in the first generation), but before they are planted (otherwise the farmer would have to apply antibiotic to the plants). Handling seed that has been soaked seems like a tricky process to me, but perhaps there are viable

methods.

At any rate, even at low concentrations there will be a lot of tetracycline to handle and dispose of, and large-scale agricultural uses of antibiotics are already seen as a threat to their medical uses. Further, the increased tolerance of bacteria and residual or waste antibiotics may also have a harmful effect on soil ecology.

Again, I am dismayed by the reductionist tone of the discussion of these issues in the patent. On page 7, line 30, the authors state:

...since tetracycline has no harmful effects on plants or animals, its presence would not otherwise impede normal development of the plant, and residual amounts left on the seed or plant after treatment would have no significant environmental impact.

While tetracycline is an antibiotic that specifically inhibits chemical processes in bacteria but not directly in humans, its indirect effects, as defined by molecular biologists, can be severe. This is because we depend on myriad interactions with microorganisms for our daily functioning, from proper digestion to pro-

The toxin could end up in products without anyone's knowledge. For example, an ornamental sunflower could spread Terminator to an oil-seed variety, and then the toxin could end up in edible oil or in sunflower seed meal.

tection from pathogens. Thus, the indiscriminate killing of bacteria does have health effects on humans (and, indeed, animals) by upsetting the ecology of the human/bacteria system. In fact, the patient information sheet that comes with any prescription for tetracycline is convincing evidence that tetracycline is not harmless to use.

Plants, too, depend on micro-organisms. They do not function normally without a web of interactions, and indirect effects from substances like tetracycline may prove to be important.

• **Will Terminator Technology prevent genetically modified organisms from escaping?**

Clearly, farmers would not want plants genetically modified with Terminator to spread into surrounding areas or to grow from seed as unexpected 'volunteers' in another season. They also would not want the Terminator plants to exchange genes with other varieties or related species. Interestingly, Terminator has been proposed as a method to prevent just such escapes of GMOs and their genes. However, Terminator is not likely to function well for such purposes.

First, it is unlikely that any tetracycline treatment will be 100 per cent effective. For various reasons, some seeds may not respond or take up enough tetracycline to activate recombinase. In such cases, the plants growing from the unaffected seeds would look just like all the others, but they would grow up to make pollen carrying a non-functional toxin gene.

The pollen would also carry the genetically engineered protein (e.g., for herbicide tolerance) supposedly being protected by Terminator. If this pollen fertilised a normal plant, the seed would not die because no toxin would be made, but the seed would now have the herbicide-tolerance gene and could pass that on. Thus a trait from the GMO would have escaped through the pollen.

Of course, self-fertilised seeds of the Terminator line would also survive in the second generation if the tetracycline treatment failed, and could be carried off by birds or grow as 'volunteers' the next season.

Another possibility is that even successfully activated Terminator genes may fail to make toxin because of a phenomenon called 'gene silencing'. In experiments with other GMOs, it was discovered—quite unexpectedly—that, in some cases, previously active (introduced) genes can suddenly stop working. If

this phenomenon occurred with seeds containing the Terminator gene, plants containing the silenced toxin gene could grow and reproduce, perhaps for several generations. Thus, Terminator and other engineered genes could be carried into the future, to be expressed—perhaps still unexpectedly—at some later time.

Depending on Terminator to prevent GMOs or their traits from spreading unintentionally is unrealistic. 'Escapes' are even more likely to occur in some of the other patent applications, where the genetic components of Terminator will reshuffle during sexual reproduction, and a portion of the seeds will lack the toxin altogether and thus be viable.

• **Will Terminator genes mutate and change characteristics in some dangerous way?**

If plants were to carry silenced toxin genes, as described above, those genes might suddenly be activated again, causing seeds to die unpredictably in subsequent generations. By the time the phenomenon occurred, however, it might be difficult to ascribe the cause to Terminator.

Another possibility is that the Terminator may be activated at a different time or place in the plant. Fortunately, such events will be self-limiting because the plants will die.

However, for farmers, the instability and unpredictability of GMOs has already been an economic problem. Genes have an ecology—a complex way of interacting with themselves and the environment—that can interfere with the simple linear logic of genetic engineering.

A recent article in *The Ecologist* discussed this problem in detail (Ho et al., 1998).

Final Thoughts on Terminator Technology

These are a few of the potential snags that I see in the use of Terminator Technology. My analysis was based on the details of only one of the applications described in the Terminator patent. I am confident that some of the particular problems I have discussed will be addressed by the seed industry before they implement the technology.

However, I am also sure that there will be other problems no one yet foresees or imagines. There will be surprises. But whatever the potential biological problems presented by Terminator, in my view they are small in comparison to Terminator's economic, social and political ramifications (see RAFI, 1998).

References

- Ho, Mae-Wan, *Genetic Engineering: Dream or Nightmare? The Brave New World of Bad Science and Big Business*, Gateway Books, Bath, UK, 1998
- Ho, Mae-Wan, Hartmut Meyer and Joe Cummins, "The Biotechnology Bubble", *The Ecologist* 28, 1998, pp. 146-153
- Horstmeier, Greg D., "Lessons from year one: experience changes how farmers will grow Roundup Ready beans in '98", *Farm Journal*, January 1998, p. 16
- Monsanto advertisement, *Farm Journal*, November 1997
- Rissler, Jane and Margaret Mellon, *The Ecological Risks of Engineered Crops*, MIT Press, Cambridge, Massachusetts, USA, 1996
- Rosenfield, Israel, Edward Ziff and Borin Van Loon, *DNA for Beginners*, Writers and Readers, USA, 1983
- Rural Advancement Foundation International (RAFI), 1998. This organisation has written several press releases, communiqués and articles on

Terminator Technology. These can be accessed at RAFI's website at <<http://www.rafi.ca>>, or by writing to RAFI, 110 Osborne Street, Suite 202, Winnipeg MB R3L 1Y5, Canada.

- United States Patent Number 5,723,765: Control of Plant Gene Expression, issued on March 3, 1998 to Delta and Pine Land Co. and the United States Department of Agriculture. Inventors: M. J. Oliver, J. E. Quisenberry, N. L. G. Trolinder and D. L. Keim.

Note: This paper (revised edition © 1988) is one in a series of essays meant to stimulate and inform discussion on genetic engineering and related subjects. The author invites readers to correspond with her directly if they have comments or questions about her interpretation of the so-called Terminator Technology patent. This is an occasional paper of The Edmonds Institute, 20319-92nd Avenue West, Edmonds, Washington 98020, USA. It has been published with the help of grants from The HKH Foundation, The Funding Exchange, and the C.S. Fund.

About the Author:

Martha L. Crouch is Associate Professor of Biology at Indiana University where she has taught about plants and agriculture for the last 20 years. She was trained in developmental biology at Yale University, and conducted research on reproduction in plants such as corn, soybeans and rapeseed for more than a decade.

In 1990, Prof. Crouch closed her laboratory over concerns that her research into the molecular mechanisms of seeds and flowers would result in applications which would strengthen agribusiness at the expense of more sustainable food production. In fact, basic knowledge of how genes are expressed in embryos, of the type done by her students and colleagues, is integral to the Terminator Technology described in this article.

Since quitting research, she has studied the relationship between science and agriculture throughout the world, with a focus on learning from traditional peasant farming.

— STAR FIRE —

THE GOLD OF THE GODS

Once the Anunnaki departed Sumeria, the preselected Master Craftsmen developed a substitute for Star Fire: a mystical bread made from the alchemical white powder of gold.

Part 2 of 3

From a lecture presented by
Sir Laurence Gardner,
Kt St Gm., KCD, KT St A.

at the 1998 NEXUS Conference held in
Sydney, 25–26 July

Transcript © Sir Laurence Gardner 1998

It was this very concept of 'being' or 'self-completeness' which posed the ultimate problem for Enlil-Jehovah. In contrast, his brother Enki knew that humans who partook of the Tree of Knowledge (the Anunnaki wisdom) and of the Plant of Birth (the Anunnaki Star Fire) could themselves become almost like gods. Even Jehovah was said to have recognised this, and Genesis states that when Adam had taken the fruit of the Tree, Jehovah said, "Behold, the man is become as one of Us".

Enki the Wise, Guardian of the Tree of Knowledge, also had another name in the Hebrew tradition. They called him Samael (Sama-El) because he was the designated Lord of Sama in northern Mesopotamia. The teachings of the early mystery-schools were very specific about the Trees of Life and Knowledge, and they emulated the very teachings of Enki himself. It was said:

Nothing is obtained simply by wanting. And nothing is achieved by relinquishing responsibility to a higher authority. Belief is the act of 'beliving', for to 'be live' is to 'believe'—and Will is the ultimate medium of the Self.

The Sumerian records relate that Cain's son, King Etana, partook of the Plant of Birth in order to father his own son and heir, King Baali—and the Plant of Birth was directly associated with individual longevity and the office of Cainship, or Kingship. It was itself related to Star Fire and to pineal gland activity, and partaking of the Plant of Birth was the ritual of ingesting the Star Fire—the pure Anunnaki female essence, the Nectar of Supreme Excellence.

In this regard, the Anunnaki 'flow-er' (flower or lily) was held to be the Cup-bearer, the transmitter of the Rich Food of the Matrix. In this capacity, she was called the Rose of Sharon (from the word *Sha*, meaning 'Orbit', along with the words *Ra* and *On*, relating to the ultimate temple of 'Light'). The significance of this highly venerated station is actually made apparent in the Bible's esoteric Song of Solomon wherein the Messianic Bride proclaims to the King, "I am the Rose of Sharon and the Lily of the valleys".

A Star Fire recipient King was considered to have become qualified for Kingship when he reached a pre-destined state of enlightened consciousness—a state when his aptitudes for wisdom and leadership had been enhanced to a realm of Kingship called the *Malkû*. It was from this Mesopotamian word *Malkû* that the Hebrews derived their words *Malchus* (King) and *Malkhut* (Kingdom).

Only in very recent times have medical scientists identified the hormonal secretion of the pineal gland, finally isolating it in 1968. The essence was called *melatonin*, which means 'night worker' (from the Greek, *melos*, meaning 'black', and *tosos*, meaning 'labour'). Those with a high melatonin output react strongly against sunlight because it affects their mental capability; they are essentially night operatives. Melatonin is called the 'hormone of darkness' as it is produced only at night or in the dark. Exposure to an excess of sunlight actually makes the pineal gland smaller and lessens spiritual awareness, whereas darkness and high pineal activity enhance the keen intuitive knowledge of the subtle mind while reducing the stress factor.

At this stage, it is of interest to note how it was that the Christian Church eventually demolished the true significance of the Star Fire ritual by manoeuvring it into the realm of sinister Gothic legend. In the old tradition, the ultimate holders of the *Malkhut* were known as Dragons or Pendragons, and the reigning head was always known as Draco.

By virtue of their bodily conditioning through supplementary melatonin and other hormonal secretions, they were in fact Princes of Darkness; and they gained their heightened awareness, above-normal powers and longevity from the Star Fire—the lunar blood of the Anunnaki Queens and the priestly Scarlet Women.

As detailed in *Bloodline of the Holy Grail*, the brutal Catholic Inquisitions of the Middle Ages were set against all the so-called heretics who in one way or another supported the Messianic Blood Royal (the *Sangréal*) of the Dragon Kings against the corrupted dogma of the bishops. Many of the victims were classified as occultists and witches, and they were charged with upholding the ancient and heretical cult of Draco, the Prince of Darkness. They were proclaimed by the Church authorities to be vampires!

I previously mentioned the significance of the ancient Egyptian Court of the Dragon, pointing out that after some 4,000 years this Sovereign Order is still operative today. Back in the 15th century, a prominent Chancellor of the Court was Prince Vlad III of Transylvania-Wallachia, who built the citadel of Bucharest. Vlad is perhaps better remembered, however, as Count Dracula, meaning 'son of Dracul'—a name by which his father was known within the Court from 1431.

Vlad was a prince of harsh disciplines, and his method of execution for crimes against the state was impalement upon wooden stakes. This was quite compatible with other hideous punishments of the time (boiling in oil, burning at the stake, drawing and quartering, etc.). But Vlad's particular method became reversed against him in a later Gothic-novel tradition which claimed that Dracula should be killed by impalement with a wooden stake.

The establishment's real fear of Dracula, however, was not his savage treatment of enemies (such things were commonplace in their day), but his in-depth knowledge of alchemy and the ancient Star Fire customs. Having attended the Austrian School of Solomon in Hermannstadt, he had an in-depth scientific understanding of the bodily effects of melatonin and serotonin which enhance longevity and increase consciousness.

Clearly, as the Romanian annals determine, he was a high melatonin producer, and, as we have seen, such people are adversely affected by sunlight. They are night workers (*melos tosos*). Consequently, the Transylvanian myth was born, and in Bram Stoker's novel (published in 1897, with its centenary last year) Vlad-Dracula was portrayed as a vampire—a Prince of Darkness who imbibed the blood of virgins!

Notwithstanding this, a good deal of truly early folklore was actually based upon the Grail and Dragon traditions. The very concept of 'fairies' ('fair folk') was born directly from this base, being a derivative of *fée* or 'fey' and relating especially to 'fate'. In the Celtic world, certain royal families were said to carry the 'fairy blood'—that is to say, the fate or destiny of the Grail Bloodline—while the Grail Princesses of romance and history were often called 'elf-maidens'. They were the designated guardians of the earth, starlight and forest, as beguilingly replicated by the elven race in Tolkien's *Lord of the Rings*.

In the old language of southern Europe, a female elf was an *ylbi*, and from this word derived the town name of Albi, the Languedoc centre of the Gnostic Cathars (the Pure Ones) in the Middle Ages. When Pope Innocent III launched his brutal thirty-five-year military assault upon the Cathars from 1208, his campaign was called the 'Albigensian' Crusade because it was set against the supporters of the *albi-gens* ('elven blood').

Melatonin enhances and boosts the body's immune system, and those with high pineal secretion are less likely to develop cancerous diseases. High melatonin production heightens energy, stamina and physical tolerance levels and it is directly related to sleep patterns, keeping the body temperately regulated with properties that operate through the cardiovascular system. It is, in fact, the body's most potent and effective antioxidant and it has positive mental and physical anti-ageing properties. It is manufactured by the pineal gland through the activation of a chemical messenger called *serotonin*. This transmits nerve impulses across chromosome pairs at a point when the cell nuclei are divided and the chromosomes are halved (a process called *meiosis*), eventually to be combined with other half-sets upon fertilisation.

Pine resin was long identified with pineal secretion and was used to make frankincense (the incense of priesthood). Gold, on the other hand, was a traditional symbol of kingship. Hence, gold and frankincense were the traditional substances of the Priest-Kings of the Messianic Bloodline, along with myrrh (a gum resin used as a medical sedative) which was symbolic of death.

In the ancient world, higher knowledge was identified as *daïth* (from which comes our word, 'death').

In fact, as we know very well, the New Testament describes that these three substances (gold, frankincense and myrrh) were presented to Jesus by the Magi, thereby identifying him beyond doubt as an hereditary Priest-King of the Dragon succession.

Yoga teachers suggest that the pineal gland (which they call the 'third eye' or 'eye of wisdom') is significant in the process of becoming 'aware', for it is the ultimate source of the Light. Illuminists and other Rosicrucian adepts have long referred to the pineal as the

secret *ayin*—an ancient word for 'eye'. This spelling (a-y-i-n) is actually quite important because the original spelling of Cain (whether with a 'C', a 'K' or a 'Q') was not 'C-a-i-n' as we now know it, but 'C-a-y-i-n'. The name Cain, in its various forms, actually denoted One of the Inner Eye. Hence, from *Kayin* with a 'K' derived the word 'King', and from *Qayin* with a 'Q' derived the word 'Queen'. Indeed, Cain's father Enki-Samael was himself the Sumerians' designated Lord of the Sacred Eye.

It is said that a truly spiritual person can automatically perceive with the third eye (the subtle eye of insight), rather than be duped by mundane eyes which reveal only physical presences. Such presences are defined by their place within arbitrary time; but to pineal graduates there is no time to calculate, for they live in a dimension where time and space are of no consequence. This dimension is not a new discovery of modern science: it was known about thousands of years ago as the Plane of Sharon, the Plane of the Orbit of Light.

And so the Cainite Kings of Mesopotamia (the first Pendragons of the Messianic Bloodline) while already being of high Anunnaki substance were fed with further Anunnaki Star Fire to increase their perception, awareness and intuition so that they became masters of knowingness, almost like gods themselves. At the same time their stamina levels and immune systems were dramatically strengthened so that the anti-ageing properties of the regularly ingested Anunnaki melatonin and serotonin facilitated extraordinary life-spans. All records of the era confirm that this was the

The name Cain, in its various forms, actually denoted One of the Inner Eye. Hence, from Kayin with a 'K' derived the word 'King', and from Qayin with a 'Q' derived the word 'Queen'.

case, with those of the kingly line living for hundreds of years. And in this regard there is no reason to be over-sceptical about the great ages of the early patriarchs as given in the Book of Genesis.

In addition to the Star Fire ritual, the Bloodline Kings were also said to have been nourished with the Milk of the Goddess, and it would appear that this 'milk' contained an enzyme that was itself conducive to active longevity. Today's genetic researchers call this enzyme *telomerase*. As recently reported in the journal *Science* [vol. 279, 16 January 1998], corporate studies and those of the University of Texas Southwestern Medical Center have determined that telomerase has unique anti-ageing properties.

Healthy body cells are programmed to divide many times during a lifetime, but this process of division and replication is finite, so that a non-dividing state is ultimately achieved. This is a crucial factor of ageing. The division potential is controlled by caps at the end of DNA strands (rather like the plastic tips on shoelaces). These caps are the *telomeres*. As each cell divides, a piece of telomere is lost, and the dividing process ceases when the telomeres have shortened to an optimum and critical length. There is then no new cell replication, and all that follows is deterioration.

Laboratory experiments with tissue samples have now shown that application of the genetic enzyme telomerase can prevent telomere shortening upon cell division and replication. Hence, body cells can continue to divide way beyond their naturally restricted programming (just as do cancer cells which can achieve immortality through being rich in telomerase). Telomerase is not usually expressed in normal body tissue; but apart from being present in malignant tumours, it is also apparent in reproductive cells. It seems, therefore, that somewhere within our DNA structure is the genetic ability to produce this anti-ageing enzyme, but that the potential has somehow been switched off and probably exists within those aspects of our DNA which scientists currently refer to as 'junk'.

In the canonical Bible we are told that, during the lifetimes of Noah and his sons, Jehovah issued the edict which forbade the ingesting of blood—at least this was the time-frame applied to the edict by the Old Testament compilers in the sixth century BC. It is unlikely, however, that this was the correct time-frame, for at that time Enlil-Jehovah would have had no such final authority over Enki and the Grand Assembly of the Anunnaki.

Nevertheless it is apparent that, from that time, the given ages of the patriarchal strain begin to diminish quite considerably, so that from the days of Abraham and Isaac we are presented, in the main, with rather more normal life-spans. In contrast, though, the life-spans of the Sumerian Kings in descent from Cain and Etana continued at a generally high level.

What we do know beyond doubt is that whatever the realities of the edict and its chronology, a major change in the Star Fire practice became necessary in about 1960 BC. This was when the Bible tells us that Abraham and his family moved northward from Ur of the Chaldees (the capital of Sumer) to Haran before turning westward into Canaan.

Contemporary historical texts record that at that time Ur was sacked by the King of nearby Elam soon after 2000 BC and, although the city was rebuilt, the power centre moved north to

Haran in the Kingdom of Mari. But Haran was not just the name of a flourishing city; it was the name of Abraham's brother (the father of Lot). Existing documents (discovered in 1934) also reveal that other cities in Mesopotamia were similarly named in accordance with Abraham's forebears—cities such as Terah (Abraham's father), Nahor (Terah's father), Serug (Nahor's father), and Peleg (Serug's grandfather).

Quite apparently, in line with all the Sumerian evidence which supports the kingly line from Cain, these lately discovered reports confirm that the immediate family of Abraham (in the succession after Noah) were also great commissioners of the region in general. Clearly, the Patriarchs represented no ordinary family but constituted a very powerful dynasty. But why would such a long-standing heritage of prominence and renown come to an abrupt end and force Abraham out of Mesopotamia into Canaan?

The answer is to be found in clay tablets which can be dated to

about 1960 BC. They detail that, at that time, everything changed in the hitherto sacred land of Sumer when invaders came in from all sides: Akkadians from the north, Amorites from Syria, and Elamites from Persia. The text continues:

When they overthrew, when order they destroyed; Then like a deluge all things together consumed. Whereunto, oh Sumer! Did they change thee? The Sacred Dynasty from the Temple they exiled.

It was at this stage of Sumerian history that the empire fell and Abraham was forced to flee northward from the city of Ur.

Clearly, the Patriarchs represented no ordinary family but constituted a very powerful dynasty.

But what had happened to the Anunnaki, the Grand Assembly of Gods who had established everything? The text continues:

Ur is destroyed, bitter is its lament. The country's blood now fills its holes like hot bronze in a mould. Bodies dissolve like fat in the sun. Our temple is destroyed. Smoke lies on our cities like a shroud. The gods have abandoned us like migrating birds.

In historical terms, this total collapse of the Sumerian empire follows the founding of Babylon by King Ur-Baba in about 2000 BC. Indeed, the story of the Tower of Babel and the resultant wrath of Jehovah precisely fits the time-frame of the Sumerians' own abandonment by the Anunnaki.

The story in Genesis relates that the people, who were hitherto said by Jehovah to be "very good", were severely punished because of a strange transgression which had not previously been ruled upon. The apparent transgression was that they all spoke the same language, and the unique language which they all spoke was, of course, Sumerian—the first written language on Earth.

For a reason which is not made clear in the Bible, the Genesis text explains that Jehovah was not happy about the Tower of Babel and so he "did come down, and did confound the language of all the Earth".

The Sumerian historical documents tell much the same story, except that the confounding of language is far better explained by the hordes of foreign invaders who came into the region. It transpires that this invasion was the direct result of friction among the Anunnaki, for at Anu's retirement from the Grand Assembly his eldest son Enlil-Jehovah assumed the presidency. He proclaimed

that he was master of all the Earth, although his brother Enki-Samael could retain sovereignty of the seas. Enki was not at all happy about his brother's claim because, although Enlil was the elder of the two, his mother, Ki, was their father Anu's junior sister, whereas Enki's mother, Antu, was the senior sister. True kingship, claimed Enki, progressed as a matrilinear institution through the female line, and by this right of descent Enki maintained that he was the first-born of the royal succession:

I am Enki...the great brother of the gods.

I am he who has been born as the first son of the divine Anu.

As a result, the people of Babylon announced their allegiance to Enki and his son Marduk—but this was all too much for Enlil-Jehovah. Having lost his popularity, he opened the gates of Sumer to let in invaders from all sides. The scribes recorded that he, the vengeful Enlil-Jehovah, brought about the "great and terrible storm" which caused the annihilation of all the Sumerian culture so that their language was no longer predominant and there was a "great confusion of tongues".

All the work which had been accomplished in building up a unique civilisation over thousands of years was destroyed in one fell swoop by Enlil-Jehovah, simply because he would not share authority with his brother Enki. The records confirm that, at that moment in Sumerian history, the Grand Assembly of the Anunnaki vacated their seats and departed "like migrating birds".

For all that had occurred up to that point, an urgent and significant change in kingly procedure was necessary because the Anunnaki Star Fire was no longer available. A substitute had to be found. As previously mentioned, the priestly Scarlet Women had been purpose-bred for this; but it was clear that, however carefully mated, their essence would weaken through the generations.

In the event, the creation of a more permanent and versatile substitute was not a problem, for this was the province of a group of previously trained metallurgists whom Enki had called the Master Craftsmen. The first of these great metallurgists to be trained was Tubal-cain the Vulcan—a sixth-generation descendant of Cain, who is remembered even today in modern Freemasonry.

In consideration of the Bible's New Testament symbology, it is of particular interest to note that Jesus' father Joseph was himself recorded in the early Gospels as being a Master Craftsman. In modern English-language Bibles, Joseph is described as a 'carpenter', but this is a blatant mistranslation. The word 'carpenter' was wrongly derived from the Greek *ho-tekton* which actually defined a Master of the Craft—not a woodworker, but a learned alchemical metallurgist in the manner of his ancestral forebears.

In the Old Testament Book of Exodus, at the time of Moses we are introduced to a certain Bezaleel (the son of Uri Ben Hur) who is said to have been filled with the spirit of the Elohim in wisdom, understanding and knowledge. We learn, furthermore, that Bezaleel was a skilled goldsmith and a Master Craftsman, and that he was placed in overall charge of building the Ark of the Covenant. In detailing how Bezaleel should manufacture various crowns, rings, bowls and a candlestick, all of pure gold, the Bible text adds to the list something called the Shewbread of the Covenant, and without further explanation the deed is seen to be done.

Although the word 'covenant' has come to be identified with contractual agreements, it originally meant 'to eat bread with', and it is pertinent to note that the Lord's Prayer (which was directly transposed from an Egyptian equivalent) specifies "Give us this day our daily bread". This is often taken to relate to sustenance in general terms, but in the original tradition the reference was more specifically directed to the enigmatic shewbread—the Golden Bread of Bezaleel.

The Book of Leviticus also refers to the shewbread:

And thou shalt take fine flour and bake twelve cakes thereof...

And thou shalt put pure frankincense upon each row.

The use of the word 'flour' in English translations is actually incorrect. The word 'powder' would be more accurate. The records of the mystery schools cite rather more precisely that shewbread was made with the white powder of gold, and this is particularly significant because in Exodus it is stated that Moses took the golden calf which the Israelites had made "and burnt it in the fire, and ground it to a white powder". In this instance, the correct word 'powder' is used, but firing gold does not, of course, produce powder—it simply produces molten gold.

So what was this magical white powder? Is there a way of using heat to transform metallic gold into a white powder which is ingestible and beneficial? Indeed there is, and it is here that the foremost alchemical principle of the Master

Craftsmen was applied: "To make gold, you must take gold."

Gold is the most noble of metals, and gold was always representative of Truth. Through the regular use of Anunnaki Star Fire (the Gold of the Gods), the recipients were moved into realms of heightened awareness and consciousness because of its inherent melatonin and serotonin. This was the realm of advanced enlightenment—the Plane of Sharon—and the Star Fire gold was deemed to be the ultimate route to the Light. Hence, the heavy, mundane person (lead) could be elevated to a heightened state of awareness (perceived as gold). This was the root of all alchemical lore thereafter.

The shewbread (or, as the Egyptians called it, *scheffa* food) was a traditional entitlement of the Israelite and Egyptian Messiahs, for the early Pharaohs were themselves fully consecrated Priest-Kings of the Grail Bloodline, having descended through Nimrod in the Cainite succession.

In ancient Egypt, the *scheffa* food was always depicted as a conical cake. According to the records, this metallic bread was used to feed the Light-body, as against the physical body, and the Light-body was deemed to be the consciousness. As far back as 2200 BC, the Pharaohs were using this supplement to enhance their pituitary and pineal activity, thereby to heighten their perception, awareness and intuition, but only the metallurgical adepts of the mystery schools (the Master Craftsmen of the Dragon Court) knew the secret of its manufacture.

In the Egyptian *Book of the Dead* (the oldest complete book in the world), the Pharaoh in search of the ultimate food of enlightenment asks, at every stage of his journey, the single overriding question, "What is it?"—a question which in the Hebrew language (as explained in *The Antiquities of the Jews*) was asked with the single word, "Manna?".

The records of the mystery schools cite rather more precisely that shewbread was made with the white powder of gold...

When the Ark of the Covenant was completed, Moses' brother Aaron was said to have placed an omer of *manna* into the Ark. This sacred *manna* was commonly associated with a mystical form of bread—the shewbread—or, as it was called in Tubal-Cain's Mesopotamia, the *shem-an-na*.

At this point, we come to a particularly important definition of the *shem-an-na*, for according to the Master Craftsmen this conically shaped (or *shem*-shaped) food was made of what the Sumerians called Highward Fire-stone.

In the New Testament Book of the Revelation it is said:

To him that overcometh, I will give to eat of the hidden manna, and will give him a white stone.

Before we look at the precise nature of the white stone of the *shem-an-na*—the bread made from the powder of alchemical gold—let us firstly consider the famous statue of Priest-King Melchizedek at Chartres Cathedral in France.

The statue portrays Melchizedek with a cup containing a stone in representation of the bread and wine which he apparently offered to Abraham, according to Genesis. The wine, as we know, was emblematic of the sacred Star Fire (just as Communion wine represents the Messianic Blood today), but the true importance of the imagery is that the bread-stone is held *within* the cup, thereby signifying that Star Fire was replaced by its substitute nourishment at the very time of Melchizedek and Abraham. This substitute was made from *shem-an-na*—the white powder of gold, the highward fire-stone.

The object of the substitute was very straightforward. Instead of feeding the recipient with a direct hormonal supplement, the powder had its effect on the endocrinal system (particularly the pineal gland), thereby causing the recipient to manufacture his own super-high levels of hormones such as melatonin.

In the famous Middle Ages Grail romance of *Parzival*, by Wolfram von Eschenbach, it is said of the Temple Knights of Grail Castle:

They live by virtue of a stone most pure. If you do not know its name, now learn: it is called lapis exilis. By the power of the stone the phoenix is burned to ashes, but the ashes speedily restore it to life. The phoenix thus moults and thereupon gives out a bright light, so that it is as beautiful as before.

Many have wondered about the name *lapis exilis* because it appears to be a play on words, combining two elements. Firstly, it is *lapis ex caelis*, meaning 'stone from the heavens', and, secondly, it is *lapis elixir*, the Philosophers' Stone by which base elements are transformed to higher states of being. Either way, or both, it relates directly to the highward fire-stone—the *shem-an-na* of the exotic Star Fire substitute.

The key to the *Parzival* allegory lies in the description that the phoenix is "burned to ashes", but from those very ashes comes the Great Enlightenment. So, what exactly is a phoenix? It is a mythical bird, we might answer. But we would be quite wrong! The word 'phoenix' is far older than the Bennu bird mythology, and it is in fact ancient Graeco-Phoenician. 'Phoenix' means 'crimson' or 'red-gold'.

Even today, within the confines of the Ordo Templi Orientis, the ancient Mass of the Phoenix is performed as a symbolic Star Fire ritual. It is pertinent to note that Bram Stoker, the author of

Dracula, was an officer of this Order—as a consequence of which, much of his novel is a coded representation of the secret knowledge. The two emblems of this ninth-degree ceremony are: the upright triangle of Gold and Light (representing spirit), and the downturned triangle of Blood and Water (representing matter). Interlocked, one upon the other, they form the familiar Seal of Solomon which contains the formula that is known as the Gem of Alchemy.

An old Alexandrian alchemical text makes particular mention of the weight of the Philosophers' Stone—which it calls the Stone of Paradise. It states that:

When placed in the scales, the stone can outweigh its quantity of gold; but when it is transposed to dust, even a feather will tip the scales against it.

In terms of a mathematical formula, this relationship is written as: $0 = (+1) + (-1)$. This appears to be a very straightforward sum at first glance, because $(+1) + (-1)$ does indeed equal zero. But when applied to physical matter it is actually an impossibility because it relies upon using a 'positive' and an equivalent 'negative' to produce 'nothing'. The moment one has a positive piece of something, it is not possible to add an equivalent negative of that something to produce nothing. At best, one could move the 'positive' something out of immediate sight—but it would still exist, and it would therefore not be nothing.

The only way to turn something into nothing, as far as the material field is concerned, is to translate that something into another dimension so that it physically disappears from the mundane environment. If that process is achieved, then the proof of achievement would lie in the fact that its weight also disappears.

What, then, is it that can outweigh itself but can also underweigh itself and become nothing? What, then, is it that can be gold, but can be fired and transposed to dust? It is the

phoenix—the red-gold that will fire to ashes but will then be restored to enlightenment. It is the golden calf that Moses burned to a powder. It is the highward fire-stone of the *shem-an-na*. And we know from the Sumerian records that this was not made of stone at all, but of shining metal.

In the alchemical tradition, the Philosophers' Stone is said to be that which translates base elements into gold. This is deemed to be the case in both the metallurgical sense and in the spiritual sense of higher enlightenment. In the physical sense, however, we must return to the oldest of all alchemical rules of the earliest mystery school: "To make gold, you must take gold."

Hence, it is determined that there are two distinctly separate forms of physical gold: the straightforward metal as we know it, and a much 'higher' state of gold—that is, gold in a different dimension of perceived matter, and this is the white powder of gold, the hidden *manna* whose secret manufacture was known only by the Master Craftsmen.

So, what precisely is the 'highward' or 'high-spin' state which converts gold (and platinum-group metals) into a sweet-tasting, impalpable white powder?

A normal atom has around it a screening potential—a positive screening produced by the nucleus. The majority of electrons going round the nucleus are within this screening potential, except for the very outer electrons. However, the nucleus goes to the

...there are two distinctly separate forms of physical gold: the straightforward metal as we know it, and a much 'higher' state of gold—that is, gold in a different dimension of perceived matter, and this is the white powder of gold, the hidden manna...

highward or high-spin state when the positive screening potential expands to bring all of the electrons under the control of the nucleus.

Electrons normally travel around the nucleus in pairs: a 'spin-forward' electron and a 'spin-reverse' electron. But when these come under the influence of a high-spin nucleus, all of the spin-forward electrons become correlated with the spin-reverse electrons. When perfectly correlated, the electrons turn to pure white light, and it is quite impossible for the individual atoms in the high-spin substance to link together. Hence they cannot reform as metal, and the whole remains simply an impalpable white powder.

The truly unusual thing about this white powder is that, through various applied processes, its weight will rise and fall to hundreds of per cent above its optimum weight, down to less than absolutely nothing. Moreover, its optimum weight is actually fifty-six per cent of the metal weight from which it was transmuted. So, where does the other forty-four per cent go? It becomes nothing but pure light, and translates to another dimension beyond the physical world. This conforms precisely with the ancient Alexandrian text—that the Paradise Stone, when placed in the scales, can outweigh its quantity of gold; but when transposed to dust, even a feather will tip the scales against it.

Some of you may recall the NEXUS publication of a lecture given by David Hudson of ORMES LLC, Arizona, in 1996 [see NEXUS 3/05, 3/06]. In this talk, David explained how he came upon the white powder production by pure chance when running laboratory tests on soil and ore samples.

During the course of his extensive research, he discovered that not only is the powder of the highward fire-stone capable of raising human consciousness, but it is also a monatomic superconductor with no gravitational attraction.

As a point of warning here, I should add that this particular powder of gold has absolutely no connection with the substances currently marketed under the labels of Etherium Gold, Isis Gold and Manatau Gold. Whatever their advertising material might suggest, none of these products contain chemically measurable gold in the highward state.

One of the great researchers into gravity from the 1960s period has been the Russian physicist Sakharov, and the mathematics for Sakharov's theory (based on gravity as a zero-point) were published by Hal Puthoff of the Institute of Advanced Studies in 1989 [*Physical Review A*, vol. 39, no. 5, 1 March 1989]. With regard to the monatomic white powder, Puthoff has made the point that because gravity determines space-time, then the powder is capable of bending space-time. It is "exotic matter", he explained, with a gravitational attraction of less than zero!

To put things into perspective, it is important to recognise that just about everything we now know about the life and civilisations of the distant BC years has been learned since the late 1800s. Prior to that, the Old Testament was one of very few documents of record. But the Old Testament was never intended to be an accurate reporting of history; it was actually a book of scripture designed to underpin a growing religious movement.

To some extent, just like the scriptures of other religions, the

Hebrew writings were based on mythological tradition, but, since the inherent stories were never found until recently in any other documented form, the Old Testament has been treated for countless centuries as if it were an absolute, factual truth.

And so the mythology became designated as history by our governing and educational establishments, and it has been taught as such in our schools and churches for the longest time.

Now we have a vast amount of original literature enabling us to be far better informed, for a great number of ancient documents have been unearthed, many pre-dating the original writing of Genesis by up to 2,000 years.

One would expect such discoveries to be welcomed with enthusiasm. But this has not been the case. Instead, they have posed severe problems and are regarded not as beneficial revelations but as threats. What do they threaten? They threaten to undermine the one-time mythology that has been erroneously dubbed as history. How does the establishment cope with this threat? It clings on tightly to the contrived history, and declares that the first-hand documents of history are mythological!

Between the 1850s and the 1930s, records which had been hidden for countless lifetimes beneath the windswept desert sands suddenly appeared, bearing the names of such well-known characters as Abraham, Esau, Israel, Heber, Nahor, Terah and many others from the Bible. These were written during the lifetimes of these men by people who were associated with them, whereas the books of the Old Testament were compiled over 1,000 years later.

But, one by one, these documents have been classified as mythology. Why? Because they tell a very different story to that which we are taught from the Bible.

Continued next issue...

About the Speaker:

Sir Laurence Gardner, Kt St Gm., KCD, KT St A., is an internationally known sovereign and chivalric genealogist. He holds the position of Prior of the Celtic Church of the Sacred Kindred of Saint Columba, and is distinguished as Le Chevalier Labhrán de Saint Germain and Preceptor of the Knights Templars of

Saint Anthony. Sir Laurence is also Presidential Attaché to the European Council of Princes (a constitutional advisory body established in 1946), and Chancellor of the Imperial and Royal Court of the Dragon Sovereignty. He is formally attached to the Noble Household Guard of the Royal House of Stewart, founded at St Germain-en-Laye in 1692, and is the Jacobite Historiographer Royal by Appointment.

Editor's Notes:

- Correspondence for Sir Laurence Gardner should be sent to: Columba House, PO Box 20, Tiverton EX16 5YP, UK.
- Sir Laurence Gardner's first book, *Bloodline of the Holy Grail: The Hidden Lineage of Jesus Revealed*, was published by Element Books, UK, in 1996 (ISBN 1-85230-870-2 h/c), and is distributed widely by Penguin Books (ISBN 1-86204-152-0 p/b). The second book in his Grail Bloodline trilogy is *Genesis of the Grail Kings: The Pendragon Legacy of Adam and Eve*, which is due to be published by Bantam-Transworld in the UK in February 1999.
- Video and audio tapes of Sir Laurence Gardner's presentation at the 1998 NEXUS Conference in Sydney are now available. Contact your nearest NEXUS office for details or, better still, e-mail us at nexus@peg.apc.org for a quicker reply.

How does the establishment cope with this threat?

It clings on tightly to the contrived history, and declares that the first-hand documents of history are mythological!

THE BUILDING OF THE GREAT PYRAMID AT GIZEH

According to this fascinating theory, the Great Pyramid incorporated a pump design that utilised water and chemical power to raise the massive stone blocks to higher levels.

An interview with
Richard W. Noone

by Alexander Horvat
First published in *World Explorer*
(vol. 1, no. 10, 1997)
© Revised 1998

Richard Noone seriously embarked on his quest to unravel some of the secrets of the ancient world when, in 1975, he started research for his book, *5/5/2000 Ice: The Ultimate Disaster*. Seven years later, he found a publisher (Crown Publishing in New York) willing to publish his findings on ancient civilisations and the role of massive Earth changes in their demise.

In 1997, Crown released a revised edition of his book with an exciting new epilogue which presents additional evidence that the Egyptians did not build the Great Pyramid with grunt slave labour dragging 20-ton, 90-ton and 200-ton blocks around the country on wooden sleds.

To quote Peter Tompkins, author of *Secrets of the Great Pyramid*: "Richard Noone's painstaking investigation into the lost technology of the sophisticated builders of the Great Pyramid of Gizeh helps to unravel the mystery of this geodetic and astronomic wonder, answering questions as to who constructed it, when, how and why. Just the manner in which the casing stones were cut to optometric precision and accurately placed and fitted without damage could not be accomplished today with the advanced engineering of our space age. Research by Noone also highlights the continued struggle of scholars against the pitted obscurantism of the local authorities who continue to block research into what must be considered the patrimony not only of Egypt but of humanity."

Noone commences with what his research reveals about how the construction of the Great Pyramid began.

"When the builders arrived, they saw a rocky knoll and a plateau that the pyramids sit on today. The first thing they had to do was level-off the construction site. The Great Pyramid is still level to within a half-inch over its thirteen-and-a-half-acre base. That is quite extraordinary; far better than we do on our buildings today. The obvious way for them to have done this would have been for them to cut channels or ditches into the rock of the site, then fill those ditches with water and drill away the rock between each ditch, using the water in each trench as a levelling mechanism.

"However, the one thing that most TV shows do not show is that the builders left a large rocky hill at the centre of the construction site. The reason for that was so that the well shaft which was dug through the rock hill to the bottom of the Grand Gallery and joins the Descending Passage underground to the Grand Gallery. What they had done was cut the one passageway straight down to the subterranean pit [referred to in Noone's book as the Chamber of Chaos or upside-downedness]. This pit has a smooth ceiling, a rough floor and a hole in it, and a saucer-shaped bowl.

"In any event, we all know that water will seek its own level. So when you have your construction site to the stage where you have a tunnel which follows a tortuous path and you have a shaft going down that joins up in an 'L-shaped' connection with the Descending Passage, you can utilise water which would be poured down that shaft, filling up the subterranean pit, and at the same time the air that was in the pit would be compressed against the ceiling. Once the water compresses the air against the ceiling of the lower compression chamber or pit, it would force water back up the lower diagonal. At one time there was a hinged granite door that only opened inward and downward, as I show in my book. Water rushing down there would go back up only until it hit this door or check valve, slamming it shut. Then, water would be forced to rise up the well shaft, the purpose being to bring water to the centre of the construction site above.

"At least one of the blocks in the Great Pyramid weighed 300 tons. Today, we don't have a crane on Earth that can lift 300 tons. The maximum lift for cranes I think is around 200 tons. Not only would a lift like that be difficult by today's standards, but positioning

the needed equipment could take more than a week to lift one block," Noone stated.

"In the early 1930s, during the Great Depression, a tremendous inventor, Edward Kunkel, began studying how the Great Pyramid was built. A friend of his commented to him, after hearing a lecture about the date and size of the stones used in building the Great Pyramid: 'I bet a fellow could make \$50 if he could figure out how it was done and write a newspaper article about it.' Kunkel in his autobiography said that \$50 was a huge sum of money back in the Depression. So this could have been his prime motivation."

In describing this unique pyramid-building theory, Noone said: "Kunkel examines every known means for lifting a weight. The phenomenal weight of the blocks that make up the Great Pyramid has boggled the mind of anyone who has studied thousands of years of stone masonry. Today, people even speculate that advanced beings from outer space came down and built the Great Pyramid, or that at one time man had somehow learned to use the power of his mind to levitate the blocks into place. Now, either one of those may or may not be true. What Kunkel did was examine the seven ways to move a mass, e.g., manually or with the use of a wedge or screw, an inclined plane, a lever, gear wheels or a pulley. One way was with the use of pumps and

hydraulics or water power. In essence, Kunkel was making a list and using a process of elimination to see which method was actually used."

Noone pointed out the flaws in mainstream thinking about pyramid construction. "Most of us are brainwashed from seeing too many television specials where the orthodox Egyptologists have shown modern-day workers pulling with ropes, muscle and human sinew a block of stone that weighed maybe a ton. You watch them and they have a tremendously difficult job moving a one-ton stone. That is a small block compared to most of the blocks in the Great Pyramid, so it has no basis in reality when you talk about some of the blocks in the Great Pyramid weighing as much as a modern diesel train engine of 90 tons. I would like to see these proponents of slaves pulling a weight with primitive methods, take a diesel train engine out to the Gizeh Plateau, take the wheels off it and pull it 50 feet up a ramp. I once saw a picture where 900 men were in harness pulling a large block in cadence (i.e., one, two, three, heave!), unlike dumb beasts of the field that couldn't pull together. The first thing I imagined when I saw this picture was the rope snapping like a kite string."

Certainly it's a worthwhile point to note that if massive ropes or chains were used, there could be handling scars from dragging on the stone. But there are no such traces of either handling scars or

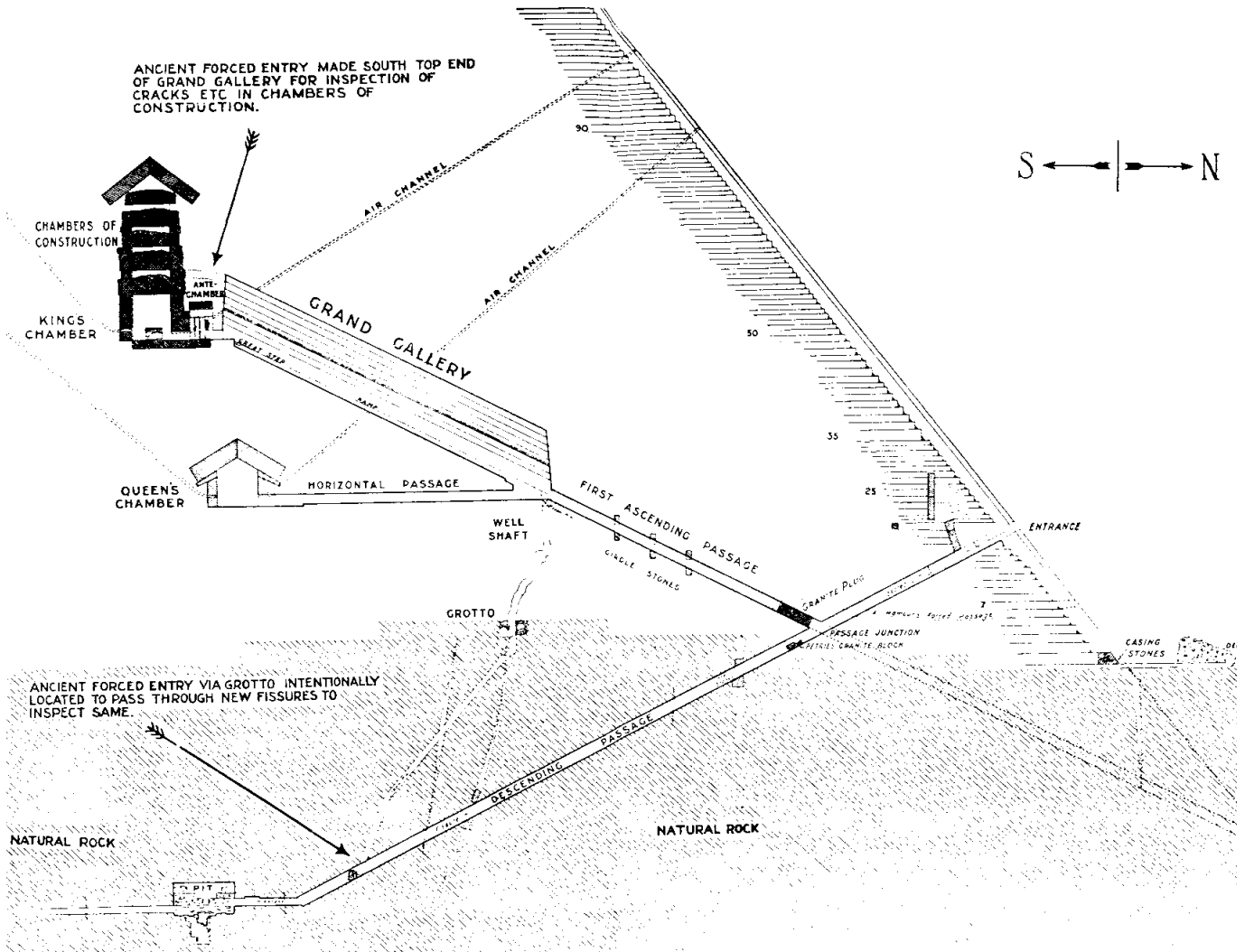

The passage system of the Great Pyramid, as it looks west. Courtesy Richard Noone, reprinted from 5/5/2000.

a ramp massive enough to accompany these huge blocks. While orthodox Egyptologists remain mired in the worn-out cliché that 'with enough people you can move anything', Noone ascribes a far greater degree of technological and engineering prowess and intelligence to the ancient Egyptians than the mainstream is willing to do.

About the ramp theory, Noone had this to say. "The single ramp theory, the long ramp, was discounted because every time a level of blocks would be laid, you'd have to raise the level of the ramp. The ramp would be a mile long and would have to be raised every time you went up a level. The ramp would consume four times more material than the Great Pyramid itself! After this theory was discounted in the early days, a clever fellow came up with the idea that spiral ramps, wrapped around the Pyramid, were used to drag the blocks up to a higher and higher level, 20 to 45 storeys high. The ramps 'somehow' stayed attached to the Pyramid with some unknown type of superglue. But turning the corners with the larger blocks of stone would have been quite impossible."

Noone suggests examining what makes sense. "Anyone who has been to the Great Pyramid will know you can still see some of the original casing stones. These are stones that are cut in five

planes—a top, a bottom, a back, two sides—and a slanted front cut at 51.51 degrees. Kunkel deduced that once the first four rows of those casing stones were put in place, you had a huge square into which you could introduce and impound water. Those casing stones would hold a pond covering the 13 acres inside of those blocks. Men would then be working waist-deep in water.

"With a simple water lock at one corner, blocks could be brought into the work pool on a barge. One man would then walk in waist-deep water, guiding a block which would be called a 'back-up block' that would go behind the row of casing stones, gently sliding it off the back of the barge to put it in place. The placement would be aided with a thin lubrication film of cement, one-fiftieth of an inch thick. This cement boggles the mind of stone masons today because it was stronger than the stone it bonded together. This is how you can handle stones without leaving handling scars. By

dragging precision-cut stones across miles of desert, you would chip them and there would be scars; but there are none on these blocks. By using water as your transport-and-setting medium, you simplify the process. When they wanted to go up higher, they would raise the level of the water that was impounded by the casing stones and add the new ones. After that, they floated in a second level of casing stones to be set on top of the first row.

"...the long ramp [theory] was discounted because every time a level of blocks would be laid, you'd have to raise the level of the ramp. The ramp would consume four times more material than the Great Pyramid itself!"

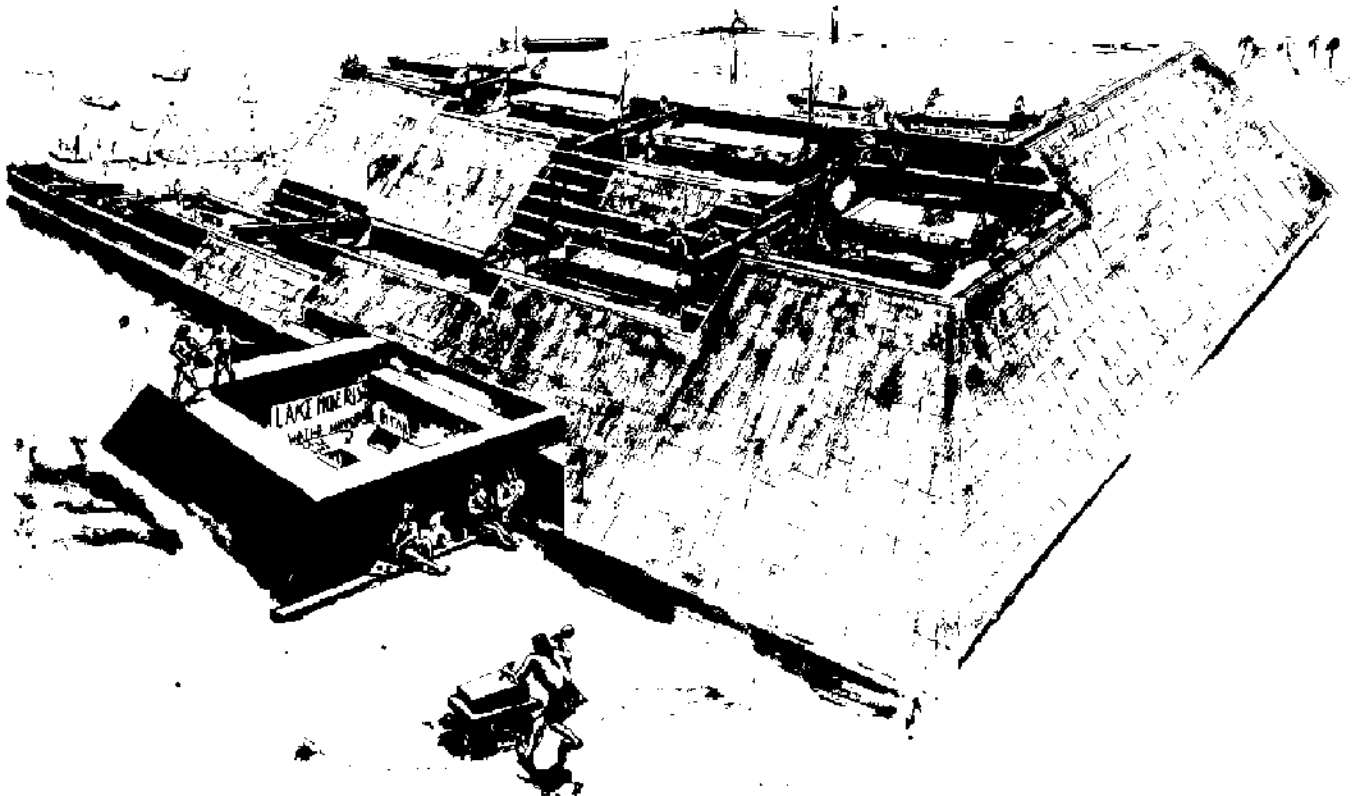

"Zig-zagging across the northern face can be traced an ancient 'carriage road'. Along its route are holes 8" round. This road was afterwards filled in with small stones. No evidence showed that it was used as such. A system of locks seemed more logical." Edward Kunkel's depiction of how the Great Pyramid could have been constructed utilising a system of water locks to float the blocks to the next highest course of construction.

"One thing that Kunkel noticed, that the others have not, was that the each of the joints or seams—which are so thin that you can't get a razor blade between them—is 35 square feet in area. This tight fit would make it leakproof or waterproof. Once the next row was added, more back-up blocks would be brought in. The Great Pyramid was built from the centre up, using a hydraulic crane to lift and lower the level of the water in the work pool."

How big a crane are we talking about? This hydraulic crane was powered by a chemical engine, as Noone describes. "In most schoolbooks today they say that the Egyptians did not know how to make any metal but copper, which is very soft. Yet, a piece of iron was blasted out of the interior of the Great Pyramid, and the fact that it was covered with cement prevented it from rusting away over the ages. We now know that the Bronze Age and Iron Age started way before Egyptologists theorise. With Kunkel's research, we know the Machine Age had already started.

"The ancient Egyptians used a chemical engine and a series of water locks to bring the stone up to the next highest course of construction. A chemical engine is something that uses a gas or fire, and this begins with a gas such as would be emitted from burning a bushel of wood. In the late 1700s, a man named Davidson found a little chamber—an opening at the very top of the Grand Gallery. This is what Kunkel calls the 'firing hole'. As you climb up the inside of the Grand Gallery, remember that the well shaft connects with the intake of the Grand Gallery and that water seeks its own level.

Pyramid = fire within

- k = king's chamber
- q = queen's chamber
- rc = relieving chambers
- gg = grand gallery
- ap = air passages

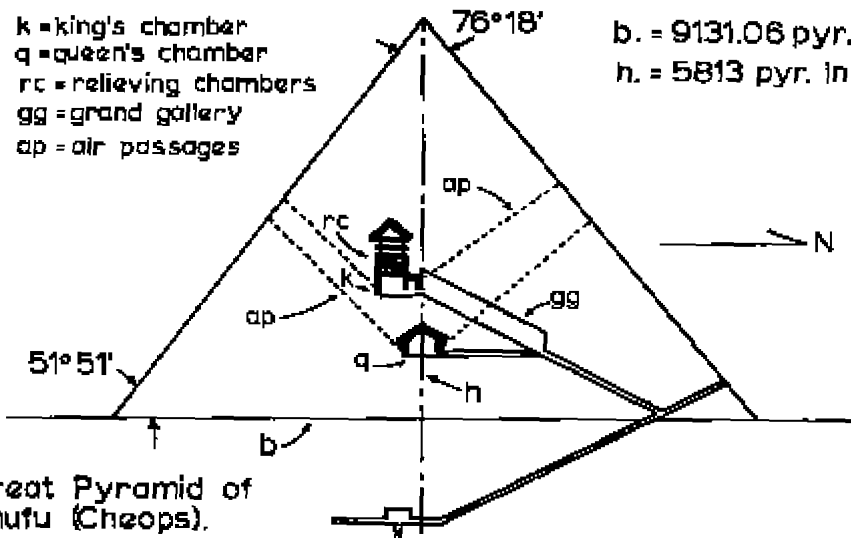

Great Pyramid of Khufu (Cheops).

Professor Nelson [Professor of Egyptology at Rocky Mountain College, Billings, Montana] suggests that if the coffer in the King's Chamber were filled with an aqueous solution of natron NaHCO_3 , NaCl and Na_2SO_4 , the salt water itself would act as an effective conductor of electricity for the piezoelectric induction from the matt-finished walls of the King's Chamber. This, Professor Nelson points out, would make it unnecessary to line the coffer with metal; the salt itself is an effective conductor of electricity. Professor Nelson correctly points out that such a process would naturally produce chlorine gas which, somehow, would have been vented from the chamber. The 'stable' organic compounds in human blood are essentially the same as sea water. A human candidate placed in this coffer during this process would experience a low-voltage shock to his brain from the electrolysed natron solution which Nelson says would have very good "health-restoring properties". (Source: 5/5/2000, p. 244)

"There is an opening in the well shaft, the grotto, that is about equal in height to the original entrance to the Great Pyramid. If you had nothing more than a bucket brigade pouring water through the entrance of the Great Pyramid, the water would rush down the Descending Passage, filling the subterranean pit. With the pit full, water would rise up the Descending Passage until stopped by the granite check valve. The compressed air in the pit, pushing against the water, would force the water up the well shaft into the grotto. From the grotto upwards, the well shaft is lined with stone.

"The ancient Egyptians used a chemical engine and a series of water locks to bring the stone up to the next highest course of construction."

"Peter Tompkins, the author of *Secrets of the Great Pyramid*, allowed me to use the very first pictures taken by Piazzi Smyth of the interior of the Great Pyramid. You can see from the grotto up to the intake of the Gallery, which is built to withstand atmospheric pressure, that the joints are so fine you can't stick a pin anywhere in between.

"What they would do to bring the water up higher from the grotto area would be to light a fire in this firing hole at the top of the Grand Gallery. The next step would be to lower the granite slabs in the antechamber. As the fire burnt in the Grand Gallery, that produced the same effect as burning a candle in a pie pan of water and placing a bottle over it. This chemical reaction would have the effect of pulling the water level up from the grotto to the top of the Grand Gallery. For those doing the experiment with the pie pan, candle and wide-mouthed bottle demonstrating this effect, you will note that when you change the fuel you double the amount of water that is sucked upwards."

Now, while this experiment only fills the bottle about one-third of the way, Noone shows that the size of the fire and the ensuing chemical reaction will move a lot more water. Plus, the addition of pressure from the compressed air in the subterranean chamber goes up the well shaft. The water is again aided by the compressed air in the Queen's Chamber, thereby making a second compression to push the water to a higher level.

The difference in chemical reactions determined by what you burn is what caused George Washington Carver in 1934 to understand how Kunkel's pump worked. Carver wrote to Kunkel: "Your explanation, I believe, is the solution to one of the greatest mysteries of the ages."

For those curious as to why the well shaft is not straight, Noone made this comment: "The reason why the well shaft is cut in such a tortuous shape requires a little understanding of Bernoulli's theory of fluid dynamics. As the water was dropped after it was brought up the Grand Gallery, the shape of that well shaft developed a tremendous whirlpool as the water fell down the shaft and through the lateral connection at the bottom. You can see it was a complicat-

ed system of compounding gravity twice, compounding atmospheric pressure twice, and working with a huge volume of water that they could raise and lower at will. As soon as they cut the two shafts and ran them together, they had the basic mechanics of a hydraulic ram pump. I would imagine that some of the larger temples in Egypt, like Karnak, were all built with impounded water to mover larger weights.

"If you read Herodotus, the Greek historian, in 440 BC he described that the Great Pyramid had a wall around it and the whole construction site around the Pyramid was filled with water. Herodotus further mentioned that there were two large pyramids built in a lake, and that there was as much of the pyramids above the surface of the the lake as there was below.

"The water Herodotus referred to originally came from Lake Moeris, formed by damming the river south of Memphis and diverting water through the Hawara Gap. It was a man-made lake, thought to be about 300 feet deep, filling the Qattara Depression, 434 feet below sea level, and, with around 450 miles of shoreline, about the size of Lake Erie. This would put it higher than the pavement of the Great Pyramid and would allow water to flow by gravity to the well in front of the Great Pyramid."

Noone cites much previous research. "In my book I show a drawing from an 1839 book by Col. Howard Vyse— *The Pyramids of Gizeh*. When they were still excavating the rubble around the base of the Great Pyramid, there was this huge well-shaft in front of the original entrance that goes 100 feet into the ground. This was another part of the water pumping system.

"In the grotto they also had a check valve that opened and closed. The door that's in the grotto had a hole drilled through it, so when they dropped that huge amount of water out of the Grand Gallery, it would come down, slam this door shut, and the flow of water going through the hole would tend to pull in enormous amounts of air. Because of that and the shape of the well shaft, as the water fell down the shaft it would develop a spin, just like a tornado.

"If you look at the temple compound constructions at Karnak, everything built there of any height originally had high walls around it so they could bring in the stones, float them up the canal and bring them into the centre of the construction site at Karnak. By raising and lowering the water level, they could build enormous structures."

To put this into perspective, Noone commented: "Kunkel was doing this research from the 1930s to his death from cancer in 1982. At that time, most history books espoused the theory that ancient man had an infantile mind and was not very smart. That is a contradiction in terms because when you go back in history and look at the architectural accomplishments such as the Great Pyramid, and we can't figure out how it was built, it's clear that we don't have the story straight yet.

"For the new edition of my book, I worked for months with James M. Hagan who is known throughout the world as an architect who specialises in building large projects. Hagan is a consultant who is often sought after when architects have big problems. Amongst Hagan's architectural designs is the football stadium and rail system in Atlanta, Georgia."

A controversial point about building the pyramids is the question of just how they cut and surfaced the stones. According to

SOLID LIMESTONE

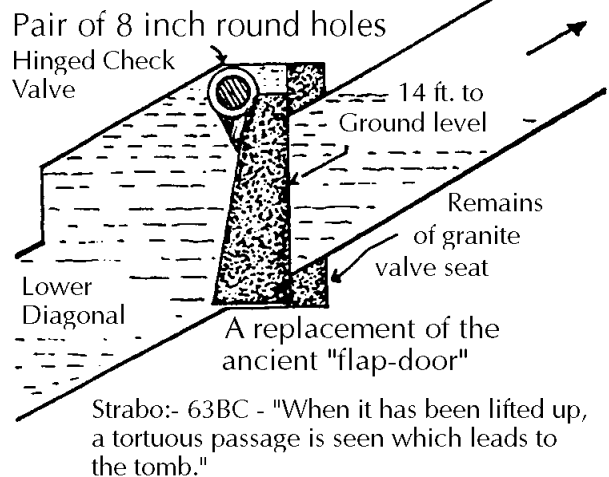

Encyclopaedia Britannica (9th ed.) describes eight-inch round holes here. Holes have been plastered over, masonry has been removed, and the whole area covered with dark red gloss paint. (Source: From *Pharaoh's Pump*, © 1962 by Edward J. Kunkel)

Noone: "To understand how they got these stones as smooth as they are, I inquired at the Indiana Limestone Institute of America. They know more about quarrying and cutting limestone than any other group on Earth. I worked with one of their technical direc-

tors, Merle Booker. In my book I reproduce a letter from Booker, stating that to quarry the amount of stone in the Great Pyramid, if they used all of their 33 separate quarries, each quarry running three eight-hour shifts per day, with all their modern equipment, it would take 27 years just to get the stone out. This idea of chiselling with big wooden mallets and copper chisels, even though we now know they had iron, doesn't make any sense. It would take far, far longer than 27 years to do it that way.

"In the new edition of my book I explain a method in which they could finish those stones of any size with the greatest of ease. They may have used wood and water to split the rocks at the quarry and get them into a block size. (Even granite will break when you put dry wooden wedges into drilled-out holes and then wet the inserted wood. The wood will expand and the next day you'll have begun to split that block.) After that, the blocks could be floated into a special cutting pool. It would be like a very large, modern-day swimming pool with a shallow and deep end. In the bottom of this special cutting pool there would be diamond cutting members. If you wanted to cut a block just as smooth as a baby's bottom, you'd start draining the water out of the pool. The weight and the pull of gravity would cause the block to start sliding down, repeatedly passing over many cutting members. When it finally reached the bottom it would be cut as fine and smooth as the lens in your glasses. Then it would be taken out of that cutting pool by a barge and another stone brought in. You could cut it easily that way in an assembly line process."

"By raising and lowering the water level, they could build enormous structures."

Kunkel was awarded a patent in 1958, but much earlier he'd built a small model of this pump after studying the diagram of the inside of the Great Pyramid. He said that after installing two check-valves he could move water through the pump.

"What are the odds," Noone queried, "that an inventor like Kunkel could come along and copy the interior of one of the oldest buildings on Earth and add a couple of check valves and get a US patent on a new type of pump?"

The fact that Kunkel innocently admitted that his pump was modelled on the interior of the Great Pyramid is believed to be the reason why it took him four years to get his patent on his new invention, as nobody believed it would work. The patent engineer who initially expressed interest in his idea would cut short the interview when the impetus for Kunkel's idea came up. Eventually Kunkel learned to change his story.

Pharaoh's Pump, Kunkel's book on the subject, is 84 pages long and is more of an instruction manual on how to operate an ancient chemical engine. This technology could be applied to help irrigate areas of the advancing desert, thus changing the climate and eventually making arid areas more habitable.

On the idea that the Great Pyramid blocks were poured like cement, Noone was asked to comment by Margie Morris, co-author with Joseph Davidovits of a book on the subject. Noone asked her to send a sample of the concrete that would have been used in the construction of the Pyramid, but he never received one—thus he became more sceptical of that method.

About the other pyramids being constructed with the same method, Noone professed no knowledge. "To date, they have not found similar passageways, like in the Great Pyramid, in the other two pyramids—at least that knowledge has not been made public if they had. However, with the power you would generate by the pump, one of the canals that goes to the second pyramid could have been powered by their original pump inside the Great Pyramid," he commented.

However, research by John Anthony West, Robert Schoch and others has shown that a long time ago, between 7000–5000 BC, Egypt had a much wetter climate. The water damage done to the Sphinx may point to a different environment around the time construction was going on. It could be that when the climate suddenly changed, man had to learn to work, move and irrigate with water in order to survive (as shown in Noone's book on p. 236).

The Great Pyramid is extraordinary for its intricate passageways and chambers and the high degree of workmanship required to build it. In 1993, German inventor/explorer/engineer Rudolf Gantenbrink created a robot that would travel the narrowest of passageways in the Great Pyramid. The exploits of this robot became the focus of TV specials but remained inconclusive, as an obstacle was discovered in one of the narrow descending passages. When Gantenbrink requested permission to journey beyond the problem area, the Egyptian Antiquities Organisation [the Supreme Council of Antiquities] denied him permission.

World Explorer asked Noone if the Egyptians were helping or hurting the further exploration and knowledge the pyramids have to offer. Noone commented: "There seems to be an information management, or what architect James M. Hagan called a 'Nilegate', going on. The explanations now offered by

Egyptologists are little more than pablum served up and spoon-fed to children. They have covered up the passageways under the Sphinx, which Kunkel shows to be a secondary pump. Zahi Hawass and Mark Lehner were shown these passageways under the Sphinx in 1980. The tunnels look the same today as the well shaft in the Great Pyramid, that I saw in 1988. When Professor Schoch asked to go into the same areas later, the permission was denied. Hawass and Lehner gained access to a vast underground complex beneath the Gizeh Plateau in 1980. Why is it being kept secret?"

A huge water tunnel under the Gizeh Plateau was briefly made known, but no other information has surfaced about it. Even accredited scientists are not allowed in these apparently restricted areas. What have they found? What are they doing down there?

In the December 1997 issue of *KMT, A Modern Journal of Ancient Egypt*, Hawass, when asked about the chamber found by the West/Schoch team using seismic sounding equipment, denied they had found anything. Noone has verified that the printout indicated a chamber, approximately 30 by 40 feet, below the Sphinx. What was stored there?

Hawass apparently keeps secret what he knows and will probably not talk. When he found out the West/Schoch team was conducting these experiments, he worked quickly to cancel their open-ended permits and get them off the Gizeh Plateau after only five days of experiments. Fortunately, they discovered the chamber where America's sleeping prophet Edgar Cayce predicted it would be.

In 1933, Edgar Cayce was asked how the Great Pyramid was built. The answer: "By the lifting forces of

those gases" (reference Cayce reading 5750-1). Cayce also said that the discovery of how the Great Pyramid was built would be made in 1958. That was the year Kunkel was awarded the patent for his pump.

About the Author:

Richard W. Noone, author of *5/5/2000 Ice: The Ultimate Disaster*, has been featured on major national media, including: Fox TV's *Prophecies of the Millennium*, The Learning Channel's *Solar Empire*, CNN Headline News, CNN Newsnight, CBS's *This Morning*, *The Oprah Winfrey Show*, *Sightings*, Art Bell's radio show, *Incredible Sunday*, WTBS, Donohue, NBC's *Ancient Prophecies*, Sun International Pictures' *UFO Diaries*, and A&E's *The Unexplained*. His research is also featured in the videos *Enter Darkness, Enter Light: The Technologies of the Gods*, and on Chris Carter's hit TV show, *Millennium*.

Mr Noone is a 32nd-Degree Freemason of the Ancient and Accepted Scottish Rite, a member of SIAHAT (Society of Inter-American Highway Auto Travelers) since 1964, and a member of the World Explorers Club. He may host a trip to Egypt for Mystical Journeys, Inc. in 1999.

Richard Noone's Internet websites are: <<http://rnoone.com>> and <www.futurefate.com>. To schedule an interviews, e-mail <bbelfiglio@randomhouse.com>.

Note: This interview with Richard Noone first appeared in the World Explorers Club journal, *World Explorer* (vol. 1, no. 10, 1997), edited by Alexander Horvat.

For enquiries about memberships and subscriptions, contact the World Explorers Club, PO Box 99, Kempton, Illinois, USA, tel (815) 253 9000, fax (815) 253 6300, e-mail <aup@azstarnet.com>. Subscription cost: US\$25, US\$30 foreign.

Edgar Cayce said that the discovery of how the Great Pyramid was built would be made in 1958. That was the year Kunkel was awarded the patent for his pump.

THE PRENTICE EARTH ENERGY TAP

This file was originally posted on the KeelyNet BBS as PRENTICE.ASC on 14 July 1994, courtesy of Louis Roy in Canada. Roy notes that it is similar to the "one-mile-wire experiment" (see KeelyNet BBS, AETHRTAP.ASC file). He advises that the patent number on his copy is incorrect, so we're not repeating it—though we have tried to find out the correct number. Roy welcomes any feedback on experimental results via KeelyNet.

US PATENT #???????
**ELECTRICAL POWER
ACCUMULATORS**
Frank Wyatt Prentice
September 18th, 1923

TO ALL WHOM IT MAY CONCERN:

Be it known that I, FRANK WYATT PRENTICE, of the City of Meadville, County of Crawford, State of Pennsylvania, Electrical Engineer, having invented new and useful improvements in ELECTRICAL

POWER ACCUMULATORS, do hereby declare that the following is a full, clear and exact description of the same.

My invention relates to improvements in ELECTRICAL POWER ACCUMULATORS and like, wherein the earth, acting as rotor and the surrounding air as a stator, collects the energy thus generated by the earth rotating on its axis and utilises the same for power and other purposes.

In the development of my WIRELESS TRAIN CONTROL SYSTEM for railways, covered by my United States Letters Patent #843,550[?], I discovered that with an antenna consisting of one wire of suitable diameter supported by insulating means three to six inches above the ground and extending one half-mile more or less in length, the said antenna being grounded at one end through a spark gap and energized at the other end by a high-frequency generator of 500 watts input and having a secondary frequency of 500,000, would produce in said antenna oscillatory frequency the same as that of the earth currents; and thus electrical power from the surrounding

media was accumulated along the length of the transmission antenna, and with a closed oscillatory loop antenna 18 feet in length, run parallel with the transmission antenna at a distance of approximately 20 feet, it was possible to obtain, by tuning the loop antenna, sufficient power to light to full candle power a series bank of 50 sixty-watt lamps.

Lowering or raising the frequency of 500,000 cps resulted in diminishing the amount of power received on the 18-foot antenna. Likewise, the raising of the transmission antenna resulted in a proportionate decrease of power picked up on the receiving antenna and, at six feet above the earth, no power whatever was obtainable without a change of potential and frequency.

It is the objective of my generic invention to utilize the power generated by the earth by means herein described and illustrated in the drawings.

The two figures in the drawings illustrate simple and preferred forms of this invention, but I wish it understood that no limitation is necessarily made as to the exact and

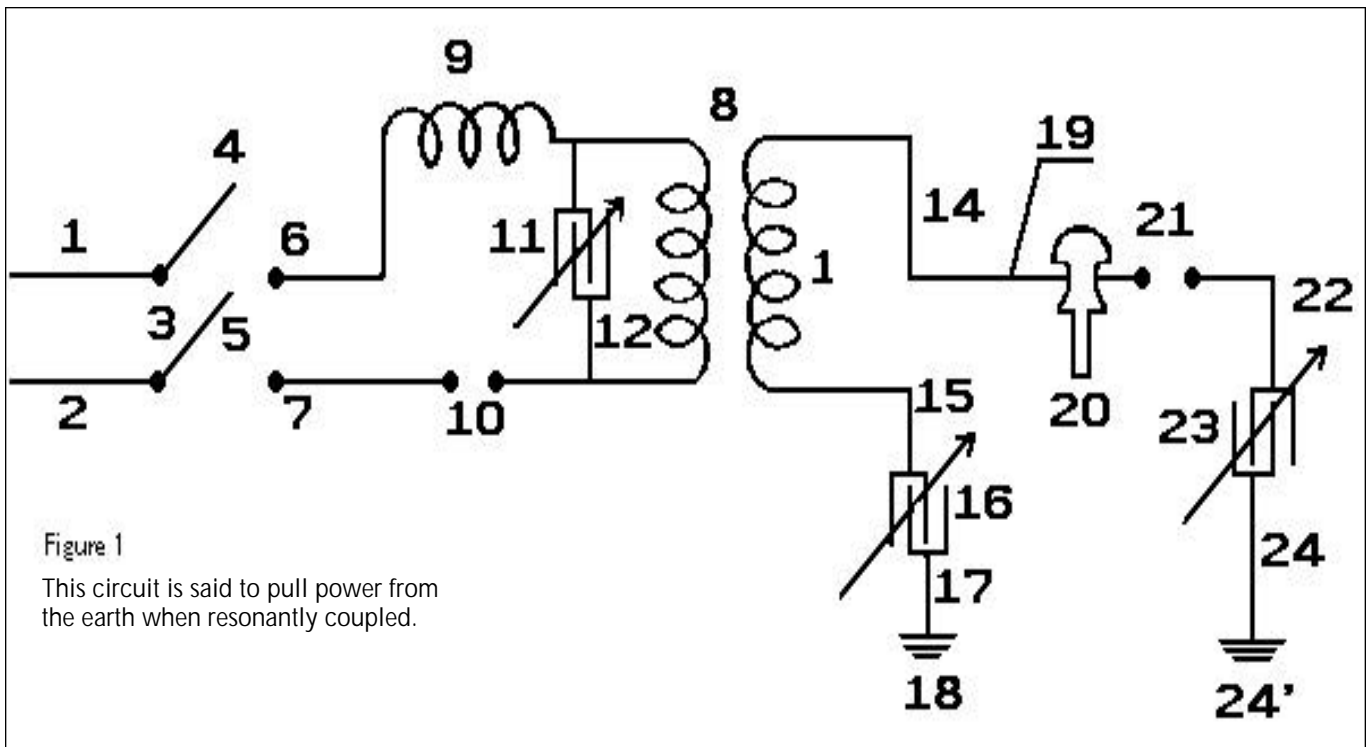

NEWSCIENCE NEWSCIENCE NEWSCIENCE

Figure 1

- 1 and 2 are alternating current feed wires supplying 110 volts 60 cycles to a high-frequency generator.
- 3 is a switch with 4 and 5 poles of same.
- 6 and 7 are connections of high-frequency transformer 8 for stepping up the frequency to 500,000 and the voltage to, say, 100,000.
- 9 is an inductance coil.
- 10 is the spark gap.
- 11 is the adjustable condenser.
- 12 is the primary winding of transformer 8.
- 13 is the secondary winding of transformer 8.
- Secondary winding 8 goes to ground through lead wire 15 to adjustable condenser 16 and lead wire 17 and 18.
- 14 is lead wire from other side of secondary winding of transformer 8 to main transmission antenna 19, supported by insulating means 20.

- 21 is spark gap from transmission antenna 19 to ground through lead wire 22, adjustable condenser 23, lead wire 24 to ground 24'.
- Transmission antenna 19 may be of any desired length.

Figure 2

- 25 is a closed oscillating loop antenna of any desired length, and for greatest efficiency is run parallel with transmission antenna 19 of Figure 1.
- 26 is lead to step-down transformer, 27 of which 27' is the secondary.
- 28 is lead to adjustable condenser 29, lead 30 to ground 31.
- 32 is primary winding of transformer 27.
- 33 is adjustable condenser.
- 34 and 35 are windings of frequency transformers supplying current through leads 36 and 37 to motor 38 or other power devices.

precise circuits, shapes, positions and structural details therein shown, exhibited and herein described in combination or otherwise, and that changes, alterations and modifications may be made when desired within the scope of my invention and as specifically pointed out in the claims.

OPERATION OF THE INVENTION:

Having described the drawings, I will now describe the operation of my invention.

Throw switch 3 connecting feed wires 1 and 2 with transformer leads 6 and 7, adjust spark gap 10 and condenser 11 so that a frequency of 500,000 and 100,000 volts is delivered from secondary leads 14 and 15 of step-up transformer 8 of Figure 1.

Next, adjust spark gap 21 of transmission antenna 14 so that all nodes and peaks are eliminated in the transmission of the 100,000 volts and 500,000 frequency along said antenna 14 by the surges occurring, pass over the gap 21 to lead 22 to adjustable condenser 23 to lead 24 to ground 24', thence the high-frequency cur-

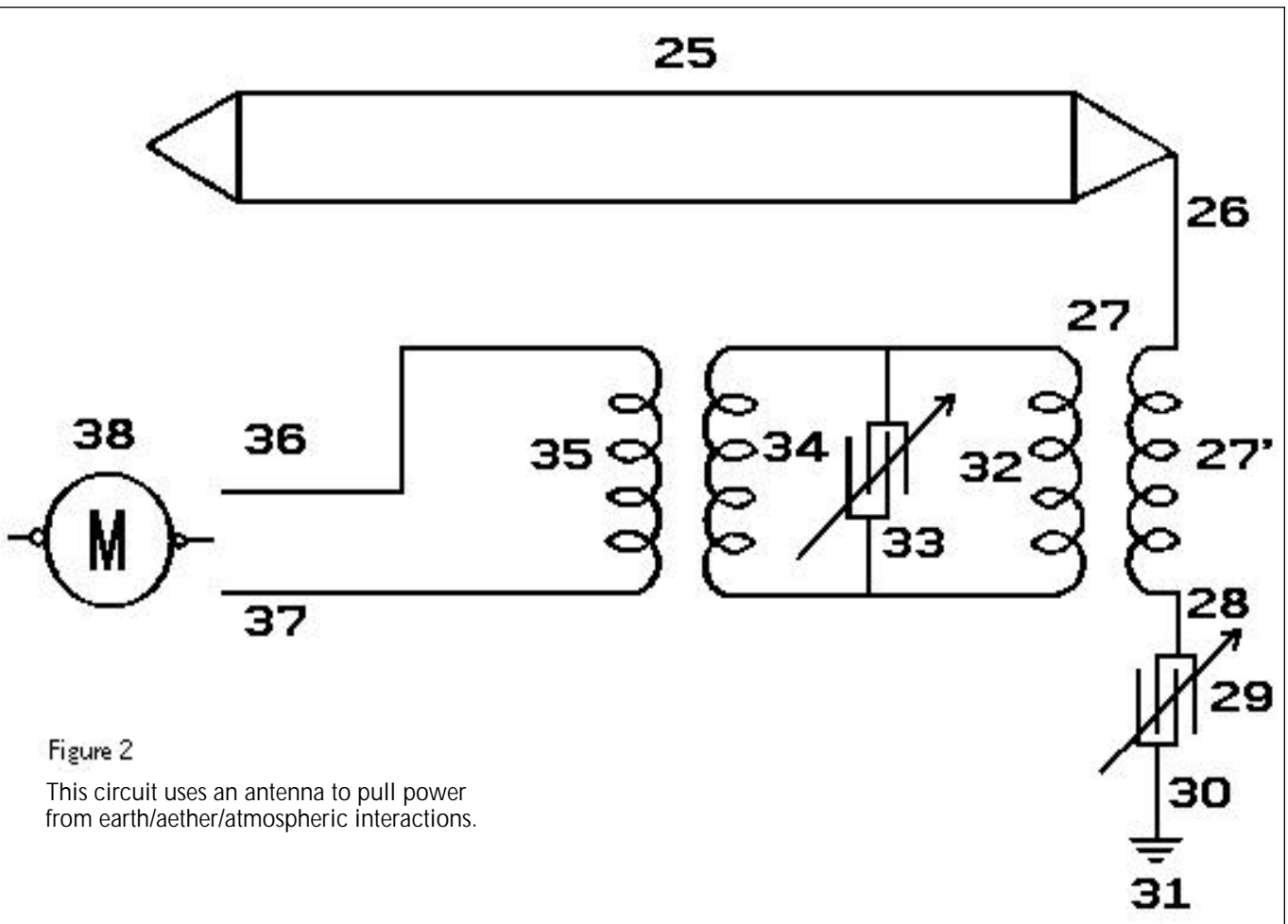

Figure 2
This circuit uses an antenna to pull power from earth/aether/atmospheric interactions.

PERPETUAL MOTION

The Story of Bessler's Wheel

In the early 18th century, the German inventor Orffyreus successfully demonstrated a so-called perpetual motion machine that utilised the force of gravity to do work.

by John Collins © 1997

From his book
**PERPETUAL MOTION:
An Ancient Mystery Solved?**

PO Box 2001, Leamington Spa
Warwickshire, CV32 6YQ, UK
Tel/fax: +44 (0)1926 424264
E-mail: permo-pubs@free-energy.co.uk
<http://www.free-energy.co.uk>

A perpetual motion machine is a device which, once having been started, continues to run for ever, without any additional input of energy.

The theory of perpetual motion has been consigned to the dustbin of discarded myths—ahead of such pseudo-scientific suppositions as UFOs, crop circles, holistic medicine and all the paraphernalia of the paranormal. The mighty weight of established scientific opinion is against such beliefs because they cannot be explained within current scientific dogma.

The dictionary definition of 'dogma' is 'settled opinion, indisputable doctrine'. Rigid adherence to current theories becomes unstuck only when the overwhelming evidence that the known facts cannot possibly sustain establishment beliefs, forces scientists to back down and look for alternative explanations.

Should the scientific establishment be accepting any of the *alternative* theories as areas of potential research? Not necessarily; but someone, somewhere, should be listening to such ideas; and if and when conflicting evidence arises, it should be discussed in an open and sensibly critical way rather than dismissed as so much hot air.

So many examples exist of accomplished scientific researchers who have been led into areas regarded as 'taboo' by orthodox scientific opinion, that the term 'scientific heresy' has been coined to describe their deviant theories. A 'heretic' is an exponent of unorthodox opinion, and 'orthodox' means 'conforming to commonly accepted opinion'.

There are many modern candidates for the application of the term 'scientific heretic' and it has become a popular subject for discussion in the media. Some competent scientists, specialists in their own fields, became aware of conflicting evidence that certain theories relating to subjects such as homoeopathy and telepathy might, after all, have some basis in truth. This evidence became so overwhelming that these same scientists published their results in the mistaken belief that such information would be welcomed by their peers. In fact, the reaction was the opposite of what they'd hoped for: some were demoted and others had their research grants removed.

By now you may suspect that I place myself among the modern heretics, and in a way you'd be right. I have discussed the subject of this book with numerous people, both professional and lay, and it is with the former that I have received a scornful dismissal of the theories advanced in it, and yet it is the very simplicity of my findings that begs for attention. I intend to show that *under certain circumstances*, perpetual motion *of a kind* is certainly a possibility—and a machine to utilise it is an absolute necessity in the face of the falling levels of fossil fuels and the rising levels of pollution that beset our planet Earth.

From an early age we are taught that perpetual motion is impossible according to the laws of conservation of energy and of thermodynamics. We are told that we cannot get more out of a thing than we have put in—a logical statement and perfectly true! I shall show you how, although this is true, it is not actually relevant to the problem. These laws and this saying have been ingrained in us, hammered into us, and we have laughed at accounts of early experiments to find the answer to perpetual motion. We find it impossible to believe that there could be a way around the problem. It is the problem of the 'closed mind'.

These days, most revolutionary discoveries are thought to have come from the ranks of educated scientists—but not so. Many ideas and contrivances have been made by men who never attended university, who were gifted amateurs or became obsessed with finding a solution to a problem that was of particular relevance to them personally. Among

these gifted amateurs was no less a person than Michael Faraday, sometimes called 'the father of electricity', yet he was self-taught. The obsessed 'suffer' from an undue preoccupation with an idea, and such ideas can arise out of need. There was surely never a truer saying than 'necessity is the mother of invention'; and in deference to those whose work could not be accepted until it was proved beyond a shadow of a doubt, as Mark Twain once said, 'A crank is only a crank until he's been proved correct'.

So what do I really mean by 'perpetual motion'? It is known by both the layperson and the scientific community that such a device would violate one or more scientific laws. There are continuing experiments in superconductivity, in which metals or ceramics are cooled to such a low temperature that they lose all resistance to the passage of a direct electric current, allowing the current to continue to flow, undiminished, in a superconducting ring. This is usually referred to as 'perpetual motion of the third kind'. It is not required to do work, but to run continuously, yet it takes enormous amounts of energy to keep the conducting material at a very low temperature. Work continues apace to find a ceramic which will operate in the same way at room temperature, and this may well soon happen but the device will still be unable to *do work*. The kind of perpetual motion which we shall be looking at is known as 'the first kind', and it *is* expected to *do work*.

Perpetual motion research can be traced back thousands of years. Behind it lies a dream of free energy which could be tapped by mankind for uses such as pumping water or turning mills. Exactly how far back the search can be traced is restricted by the fact that we must rely on written records. A fifth-century Sanskrit manuscript on astronomy, *Siddhanta Ciromani*, describes



Johann Ernst Elias Bessler, also known as Orffyreus.

an attempt at a perpetual motion machine, but this is unlikely to have been an isolated example, even at this early period. If *one* person saw a need for such a device at that particular time, then others would have done so, but they might not have gone into print. I suspect that if written records were available, they would show that the search for perpetual motion began a long time before the fifth century. Indeed, there is a certain amount of evidence that pushes the date back some 7,000 years.

Our modern educational system has ruled out any chance of such energy generation; but in the 18th century, things were not so definite. Heated discussions continued as to the possibility of perpetual motion. Some believed it might be feasible under certain circumstances. Others, the majority of the scientific establishment, declared such an idea outrageous, ridiculous or impossible. It was known that the ultimate problem was one of friction, and work would only increase the effect that friction was already having. Heat was a consequence of friction, and the heat was readily dissipated to the surrounding cooler air, just as the law of thermodynamics suggested. There would never be enough energy held, within a machine, to draw on for more than a few hours at best, and it would not actually be able to do any work.

There are only two laws of thermodynamics, and the first one says that a certain amount of mechanical work will produce an equivalent amount of heat. In other words, energy can be converted into heat, but it can't be destroyed or created. The second law says that heat cannot be increased without the expenditure of more work, or energy. This means that heat can only flow out to cooler surroundings; it can't do the reverse. Today these statements seem very obvious and, when combined with the laws of motion as defined by Sir Isaac Newton, appear to rule out the possibility of perpetual motion.

The first law of motion states the rather obvious fact that a body or thing which is at rest, i.e., not moving, will continue to remain at rest unless acted upon by an external force, i.e., if something pushes it. It goes on to mention that if the body is moving in a particular direction, it will continue to move in that direction unless acted upon by some external force, i.e., if something causes it to change direction. The second law elaborates on the first law in that it states that the action of something pushing or striking a body in motion is the same in magnitude and direction as if it acted on the body at rest. The third and final law says that every action has an equal and opposite reaction—and anyone who has ever attempted to ice-skate will vouch for the truth of this.

So these are the laws which, in part, help to exclude the possibility of perpetual motion, and they cannot be faulted. Actually, they are statements of fact that grew out of the writings of the ancients such as Thales, followed by Copernicus, Kepler, Galileo and Descartes. Newton combined the work of his predecessors and then added his own unique brand of genius, producing his *Principia Mathematica*.

Remarkably, it seems that Newton himself did not rule out the possibility of a perpetual motion machine. It is a little-known fact that in his early notebooks, under the heading "Quaestiones" (*sic*), Newton speculated that gravity (heaviness) is caused by the descent of a subtle matter which strikes all bodies and carries them down: "Whither ye rays of gravity may bee stopped by reflecting or refracting ye, if so a perpetual motion may bee made one of these two ways." Adjacent to these words, Newton added two sketches of perpetual motion powered by the "flux of the gravitational stream". Moreover, Newton became directly involved in a famous controversy regarding a perpetual motion machine, but, although challenged to comment on it, he maintained a dignified silence.

I mentioned that 'perpetual motionists' were busy in the 18th century. However, earlier than that, in 1623, the King of England passed an Act which eventually led to the establishment of the British Patent Office. Inventors were allowed to retain the rights to their own invention and to secure a monopoly on their idea for a certain length of time; thus they were given a chance to develop their invention and exploit it without competition. In 1635, a patent was granted for a perpetual motion machine, but we know nothing about it, as no description exists. In 1903, some 268 years later, nine applications for perpetual-motion-related devices were received by the patent office. In those intervening years the patent office dealt with over 600 applications that claimed designs for a perpetual motion machine!

It did not end then, but perhaps due to the improvement in education of more people and the widely held belief in the impossibility of perpetual motion, potential claimants to the secret have discovered that discretion is the best policy against a scornful public. Little is heard of the secret experiments in sheds and garages by amateur inventors still trying to solve the ancient puzzle. However, a glance through the back issues of such well-known publications as *Life*, *Newsweek*, *Smithsonian*, *Esquire* and *Science Digest* will reveal articles on several modern inventors who believe it is just a matter of time before they solve the conundrum with a working model demonstrating perpetual motion.

Suppose one man did claim to have discovered the secret. What if he did make a working model? What if he exhibited it to the public? What if he submitted it for testing by the top scientists of the day? What if it passed every single test that could be devised? And what if he offered it for sale for £20,000, but was unable to find a buyer who would adhere to his strict but fair conditions? What if one man did all that, and eventually died in poverty thirty-three years later, still exhibiting his machine, still hoping that someone would believe him, and still with his secret unrevealed, unsold and unsolved? Can this be possible? Could someone have succeeded where all before had failed?

Astonishingly, history does record just such a man. His full name was Johann Ernst Elias Bessler (1680?–1745), but he was better known by his coded pseudonym, 'Orffyreus'.

Nearly 300 years ago in a small town in Germany, a most remarkable thing happened. Johann Bessler, or Orffyreus as he liked to be called, had perfected his new invention, and he let the local people into his house to see it in the hope of his selling the secret to some wealthy patron for a large sum of money. The precise date was 6 June 1712 and the town was Gera.

Reaction to Orffyreus' invention surpassed his expectations. Word spread and a crowd gathered around the device (which took the form of a narrow drum mounted on a pair of supports). Things got to the stage where the inventor had to close the exhibition. Later, Orffyreus had the machine cordoned off in an attempt to control the viewing of his prototype perpetual motion machine,

but even this was insufficient. He had no desire to prevent the townsfolk seeing his wonderful wheel, but he was not prepared to risk the secret of its construction becoming known. So, following his brother Gottfried's advice, he began to ask a small charge for admission, giving all proceeds to the poor, and this did help to reduce the crowds to more manageable numbers.

The machine was not large; it was three feet (just under a metre) in diameter and four inches (about 10 centimetres) in depth. It was held stationary by a cord attached to the rim. As soon as the cord was released, the wheel began to revolve, slowly at first but gathering speed rapidly until it was revolving at a speed of 50 revolutions a minute. It had to be forcibly stopped, but, according to the inventor, if allowed to it would spin at this speed until the parts wore out. He promised that a larger machine could be constructed which would be much more powerful.

Over the next four years, Orffyreus responded to ever more restrictive demands and more severe requirements that his machines perform this test or that test, by producing improved wheel after improved wheel.

News of Orffyreus' wheel spread to the farthest corners of the Western world. In England it met an impressive wall of disbelief, among the scientific community at least. Reports reached the ear of Peter the Great, Czar of all Russia, who went to considerable lengths to buy the secret. Perpetual motion was discussed by scientists, philosophers, statesmen, envoys and their rulers. Heated disputes arose over whether perpetual motion was possible and whether Orffyreus had to be a fraud and a charlatan to make such claims. Anyway, how could a mere market trader have discovered something that had eluded the finest intellects the world had ever known? But Orffyreus was far from a mere market trader.

The general populace was curious about Orffyreus' invention, but the same could not be said for the intellectuals. Letters virtually spitting venom were fired off from one scientist to another in an attempt to prove that Orffyreus was a liar. Others refused to discuss the matter; their open, enquiring minds snapped shut.

The most vociferous and therefore the most widely listened to, was a small group of men from the town of

Dresden, led by the Master Model-maker to the King of Poland. This man, Andreas Gärtner, published—or had published by his followers—the most slanderous tracts and pamphlets mocking Orffyreus or challenging him to come clean and admit that his machine was a fake. There was no recourse to the law, such as a claim for libel, so there was little Orffyreus could do other than go into print to defend himself. This he did with great enthusiasm, pouring out on paper all his hurt and injured pride.

Over the next four years, Orffyreus responded to ever more restrictive demands and more severe requirements that his machines perform this test or that test, by producing improved wheel after improved wheel.

After the success of his first wheel, the small one at Gera, Orffyreus constructed a larger version which measured five feet (1.5 metres) in diameter and turned as the others had done, without stopping. Wonderful as this machine was, it still attracted criticism: "It is still too small"; or "A larger one would be more

useful"; or "A larger one would not work because, as everyone knows, the larger a machine is, the less efficient it becomes".

These were the kind of comments made about the wheel. The most telling one, in the opinion of the inventor, was the published statement by his enemy Gärtner—that the machine was wound up, and the winding was the source of its motive power. Orffyreus went away to ponder and came back with an irrefutable argument. He made a wheel that could turn in either direction, thus obviating the possibility of a clockwork mechanism.

This did not silence his enemies. Gärtner was joined by Christian Wagner, a student of mathematics, whose published tracts were, if anything, even more vitriolic than Gärtner's. Wagner tried to claim that Orffyreus had fitted some kind of split axle to his wheel in order to allow it to change direction. He did not explain how this might have been achieved, and he became something of a target for Orffyreus' sarcasm.

The new machine was submitted for examination and passed all the tests. As usual, these results were insufficient to satisfy those who believed that the inventor was a fraud, and Orffyreus left town yet again—after smashing his wheel to pieces in disgust.

News continued to spread of the inventor's work and the remarkable claims made for it. The Landgrave of Hesse-Kassel granted patronage to Orffyreus, made him a Commercial Councillor and invited him to rebuild his wheel, bigger and better than ever before. This Orffyreus did.

In 1716 he produced his biggest and most amazing device ever. This largest construction was in the form of a wheel or drum, 12 feet in diameter (slightly under 4 m), about 18 inches in depth (about 46 cm) and weighing around 700 pounds (317 kilograms). It was started with a gentle push, using two fingers, and quickly reached a speed of 26 revolutions a minute, at which it could raise a load of bricks weighing 70 pounds (nearly 32 kg) or turn an Archimedean screw for pumping water. Even more remarkably it could be stopped with tremendous difficulty and made to turn in the opposite direction where it would perform as before.

The machine successfully underwent an extended test—under lock and key and armed guard—for a period of 54 days (nearly eight weeks) without stopping. To this evidence one should add

the numerous smaller tests and the most thorough examinations of everything visible on the wheel—except for the internal workings which, it was admitted, the inventor had a right to keep secret (until the desired purchase price had been agreed and paid).

But in spite of the successful tests, his enemies would not leave him alone. To Orffyreus' dismay, the detractors eventually won the day. In fact, from the moment he first demonstrated his invention, a storm of controversy had swiftly established itself and raged about him. When he died thirty-three years later, alone, in poverty, and still claiming that the invention was genuine and his own, and that he'd never been proved a liar, that storm, that hurricane of controversy, had not abated in the slightest.

The legend of Orffyreus' wheel is fairly well known, but by omission and distortion of the facts, the real story has never been told. Most of the information which appears in every encyclopaedia, in whatever language, tends to originate from one particular source.

In 1795, fifty years after Orffyreus' death, Friedrich Wilhelm Strieder published a biographical dictionary which includes an account of the inventor's life. In it, Strieder mentions that he used Orffyreus' own published writings as a source of information, complaining at the same time that he needed "great patience, I must say, since it is a truly abominable piece of prose". In fact, the account is written with some style and considerable wit and humour, but is overly long and repetitive when complaining about his enemies. I can understand that one might need patience to read all of it—Orffyreus' writing does suffer from an excess of verbiage—but it is not "abominable".

The veracity of Strieder's account of Orffyreus' life can be checked, fortunately. There are many Orffyrean tracts extant in which he describes his life, so the two versions can be checked for discrepancies. It is fairly obvious that Strieder had a very poor opinion of the inventor, and he does not hesitate to let us know on several occasions, but I have not been able to find any glaring difference of a factual nature between the two accounts. There is, however, a tendency to be selective in the use of certain facts. Strieder lays greater emphasis on some facets of the story, whilst playing down other aspects.

Another source for accounts of the actual devices exhibited by Orffyreus are the newspapers of the day, and they provide much information about both the dimensions of the 'wheels', as they were called, and the prevailing opinion regarding the possibility of perpetual motion.

However, the best mine of information lies in the numerous letters written about the Orffyrean machine. Two of the most striking and convincing letters came to my attention through the efforts of William Kendrick (1725?–1779), a rather pathetic character who made a living penning literary articles. Kendrick actually died while waiting for the patent office to grant him a patent on his own design of a perpetual motion device. Whether it existed outside his own imagination is difficult to say, but certainly he was a believer in the possibility, and, indeed, gave a course of lectures on the subject.

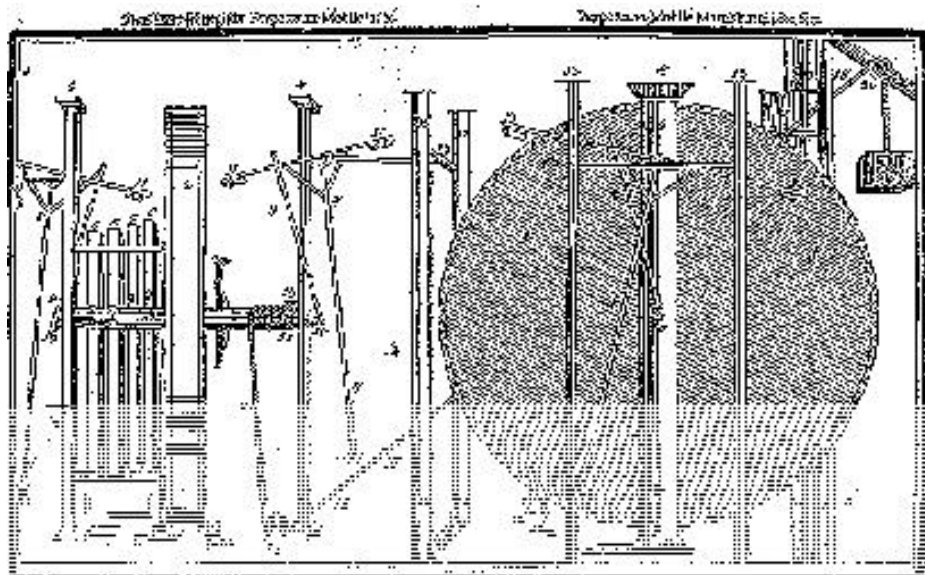

From Johann Bessler's first publication, *Grundlicher Bericht*, published in 1715.
(Source: From *Perpetual Motion: An Ancient Mystery Solved?*, © 1997 by John Collins)

But to return to Strieder, his account continues, albeit sketchily, from the time of the big Kassel wheel, up to the inventor's death. Unfortunately, we only have Orffyreus' own account of his life up to and including the building of the last wheel. It is therefore harder to determine how much faith to place in Strieder's account of Orffyreus' life after 1719 because we have nothing to compare it with, except what we can piece together from the numerous letters and newspaper reports. It is reasonable to assume that Strieder's account was a factual rendition of events, but biased. The reason for this bias is not hard to find.

In his search for information, Strieder turned up some extremely damning pieces of evidence—namely, no fewer than seven sworn statements to the effect that the inventor was a swindler and that they, the witnesses, had been forced to take part in the fraud and had been sworn to silence by Orffyreus. Most of the witnesses were either relatives of Orffyreus or his servants.

This evidence has been the overwhelming factor in the demise of Orffyreus' reputation, notwithstanding the fact that perpetual motion even at that time was regarded as a scientific impossibility. Faced with these facts, the reader may well feel it is pointless even to suggest that there could be anything other than fraud connected with the Orffyrean machine. All is not as it seems, however.

The biographer only reproduced two documents as examples, and as if these weren't bad enough he summarised accusations from some of the other documents. For instance, he stated that Orffyreus' "wife confirmed in great shame that she was forced to swear five oaths to her husband—who always carried consecrated wafers, but was a desperate man who cared for nothing—and that, in the end, she nevertheless felt obliged to confide secretly in a man who was bound by oath and duty, but that that man decided to take her treacherous husband's side and do nothing, even warning her of the most frightful consequences of any further action".

Can there possibly be any doubt of Orffyreus' guilt? History does not think so, and I wouldn't have had any doubt except for my finding one small, seemingly insignificant phrase which cast doubt on the authenticity of the evidence.

In a document dated 28 November 1727, Orffyreus' maid gave the following statement, as recorded by Strieder:

"The posts had been hollowed out and contained a long thin piece of iron with a barb at the bottom which was attached to the shaft journal. Turning was carried out from Orffyreus' bedroom which was close to the machine, on a shelf behind the bed."

The first area of concern was the maid's statement regarding the secret mechanism. It was, frankly, impossible. Whatever mechanism moved that wheel, there is absolutely no way that it could have been driven by the means described. Twelve feet (3.6 metres) across, 18 inches (45.7 cm) thick, and weighing an estimated 700 pounds (318 kilograms), and the whole construction turned on a pair of bearings measuring just three-quarters of an inch! And what is more, it accelerated from a very slow speed to one of between 25 and 26 revolutions per minute in just three revolutions!

The maid stated that the posts were hollowed out and a barbed piece of iron inserted and connected to the shaft journal. Anyone giving reasonable consideration to this account will see that the power and strength required to keep a machine of this size turning, by applying its force *through the bearings*, would be enormous. And besides, where would one find a metal of sufficient strength to withstand the tremendous load placed on it? Not only that, it had to be kept turning for *almost eight weeks*—and was expected to do work, i.e., raise a box of bricks weighing 70 pounds and turn an Archimedean screw. Forget the problem of actually devising a mechanism which would operate inside a wooden post connected to a bearing at one end and a small wheel at the other!

It is hard for me to convey the utter certainty in my mind, of malicious intent by the maid. I am sure that whatever criminal accusations may be laid at Orffyreus' door, the maid's account is fictitious.

And if this part of Strieder's evidence, the key part, is faulty, how much reliability may be placed on the rest of his evidence?

During Orffyreus' efforts to achieve recognition for his perpetual motion machine, his claims came to the attention of Karl, the Landgrave of Hesse-Kassel. He was similar perhaps to a Duke in England, and as such he ruled a small

Dukedom, whose capital was the town of Kassel. It is recorded that he was the only man whom Orffyreus ever allowed to see inside the wheel. He was sworn to secrecy, and he never broke his word.

It puzzled me to think that if he had seen the inside of the wheel, he obviously knew the truth, and yet no mention was made in Strieder's biography of any comment by Karl following Orffyreus' arrest for fraud. He took Orffyreus and his machine under his patronage, and even made the inventor Councillor of Commerce for

Hesse-Kassel. Could he have been a party to the subterfuge? Or might he have been duped by a plausible rogue? Or, the only other possibility, was Orffyreus telling the truth? Had he *really* invented some kind of self-propelled machine?

About the Author:

John Collins has worked within the engineering industry for most of his life, and has been intrigued and mystified by Johann Bessler's life and work for much of the last 30 years. He is experimenting with his own prototype based on Orffyreus' wheel and is having encouraging results. Collins is the author of *Perpetual Motion: An Ancient Mystery Solved?* (reviewed in NEXUS 5/03, April-May 1998). He can be contacted at PO Box 2001, Leamington Spa, Warwickshire CV32 6YQ, UK; tel/fax +44 (0)1926 424264; website <<http://www.free-energy.co.uk>>.

Editor's Note:

To exchange information on experiments with Orffyreus' wheel, contact

- in UK: John Collins (as above)
- in Australia: Jan Rutkovski, tel (08) 8258 5039
- in USA: KeelyNet, PO Box 1031, Mesquite, TX 75150, tel (214) 324 3501, website, www.keelynet.com

Copies of *Perpetual Motion: An Ancient Mystery Solved?* can be obtained through NEXUS offices in Australia, NZ, UK and the Netherlands. In the USA, we suggest you phone Adventures Unlimited Press on (815) 253 6390.

...it had to be kept turning for almost eight weeks—and was expected to do work, i.e., raise a box of bricks weighing 70 pounds and turn an Archimedean screw.



EX-ASTRONAUT EDGAR MITCHELL SPEAKS OUT ON ETs

Former NASA astronaut and scientist Edgar Mitchell is one of only twelve people to have walked on the Moon. Mitchell caused a sensation at a UFO conference in the US in October when he claimed he has seen proof that aliens exist.

In 1971, as an Apollo 14 astronaut, Mitchell became the sixth person to have walked on the Moon. Now 68, he works as a consultant to the acclaimed science fiction TV series, The X Files.

In a recent interview for a London magazine, Edgar Mitchell told why he is convinced there is life on other planets and that extraterrestrials have landed on Earth.

I am an American astronaut and a trained scientist. Because of my position, people in high places confide in me. And as a result, I have no doubt that aliens have visited this planet.

The American Government and governments throughout the world have thousands of files of UFO sightings which cannot be explained. As a scientist, it is logical to me that at least some of these will have been witness to alien craft.

As a former astronaut, the military people who have access to these files are more willing to talk to me than to people they regard as mere cranks. The stories I have

heard from these people, who are more highly qualified than I am to talk about UFOs, leave me in no doubt that aliens have already visited Earth.

I've been interested in the subject since I joined NASA 40 years ago. Probably my most visionary moment was when I actually landed on the Moon with *Apollo 14*.

I felt an overwhelming sense that the universe itself is in some way a conscious

being in its own right. This means that all life-forms, whether on Earth or elsewhere, are all part of one giant consciousness.

So when I learned that aliens really do exist, I wasn't too surprised. But what did shock me, when I started investigating extraterrestrial reports a decade ago, is the extent to which the proof has been hushed up.

It isn't just the US Government which

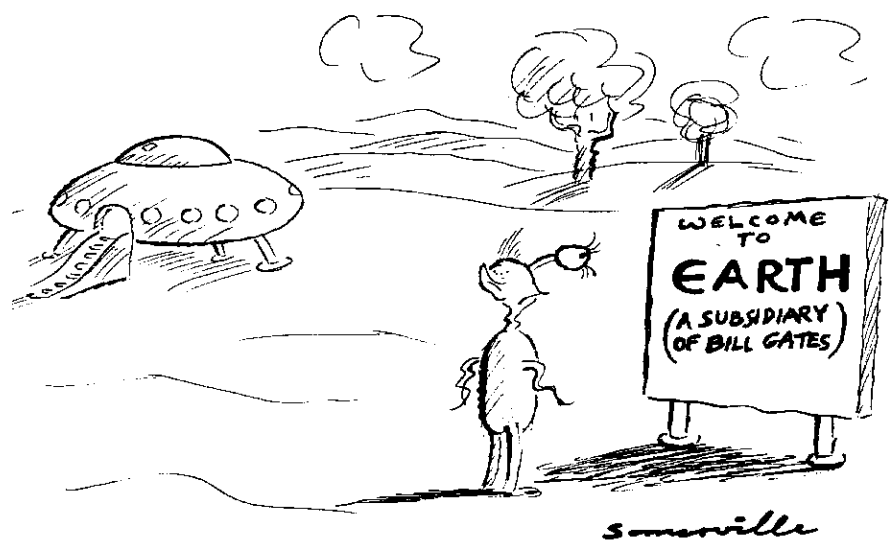

THE TWILIGHT ZONE

has kept quiet about alien visits. It would be arrogant of an American like myself to assume that ETs would only choose to visit my country.

Indeed, I've heard convincing stories about governments all over the world—including the British Government—that know of alien visits.

Not all governments are anxious to keep their findings quiet. The Belgians have admitted that aliens may be out there, and have released information about sightings that cannot be explained away as military planes, weather phenomena and so on.

There is a very simple reason why governments have been so secretive: fear.

Modern UFO sightings really began with the Roswell incident in 1947, when a crashed craft containing the corpses of several aliens was found in Roswell, New Mexico. Make no mistake...Roswell happened. I've seen secret files which show the government knew about it, but decided not to tell the public.

There were very good security reasons for not informing the public about Roswell. Quite simply, we wouldn't have known how to deal with the technology of intelligent beings advanced enough to send a craft to Earth. The world would have panicked if we'd known aliens were visiting us.

The question of whether or not aliens are still visiting us is more complex. Such is

our existing secret technology that what might look like an alien craft may well turn out to be a top-secret military plane. On the other hand, the craft may be an alien spaceship. Personally, however, I'd say yes, it's quite possible we are currently being visited.

The whole question of extraterrestrials should be looked at in an historical context. Five hundred years ago, the astronomer Copernicus was condemned as a heretic for saying that planet Earth wasn't the centre of the universe but merely a small part of it. Now we laugh at those long-dead fools for not listening to the truth.

People who believe in aliens aren't all cranks, and some may be looked upon in the future as visionaries similar to Copernicus. Meanwhile, the majority of us still believe mankind is the biological centre of the universe.

We will refuse to accept that intelligent life exists outside Earth unless we personally bump into an alien while we're doing the shopping. Is this attitude really any different from those 'simpletons' of 500 years ago?

My training at NASA only allows me to look at things scientifically. Even if I had not been shown evidence of alien landings on Earth, the assumption must be that somewhere in the universe another planet is capable of supporting alien life. Those

life-forms need not be 'little green men'. The scientists' definition of intelligent life is whether or not it can use and manage information. Even the most primitive microbes on Earth qualify by that definition, and surely there are, at the very least, similar microbes thriving on planets throughout the universe.

If you are starting to think that walking on the Moon added my brain and that I'll believe any old crank theory about ETs, think again.

I would describe myself as a cynic. I was not convinced about the existence of aliens until I started talking to the military old-timers who were there at the time of Roswell. The more government documentation on aliens I was told about, the more convinced I became.

It must be stressed that the wackier people on the fringe of alien matters do the subject no end of damage. Contrary to rumour, there are no alien buildings and structures on the Moon. I should know—I was there!

I even became caught up in these rumours when a theory started that a Moon 'structure' was reflected on my helmet during TV transmissions of my landing. That just isn't true. It's that kind of disinformation which stops credible people admitting that they, too, believe in aliens.

Thankfully, things are changing for the better. It's a snowball effect: the more scientists admit that ETs are a viable prospect, the more they are investigated in a scientific manner. And the more that happens, the more chance there is of our discovering inarguable proof of extraterrestrials.

It helps, too, that those in possession of documentation of alien visits to Earth are starting to come forward. The military people I spoke to are tired of the secrecy surrounding Roswell and similar cases, particularly as the information is being leaked.

I firmly believe that this documentation will have to be made public within the next three or four years. And if proof of ETs is finally made public, nobody will be happier than me.

What I don't think will happen is that I will ever see an extraterrestrial. I'd love to see one, though it's not the biggest priority in my life. But, as they say on a TV show I'm associated with, the truth is out there.

(Source: John Earls, *The People*, London, 25 October 1998)

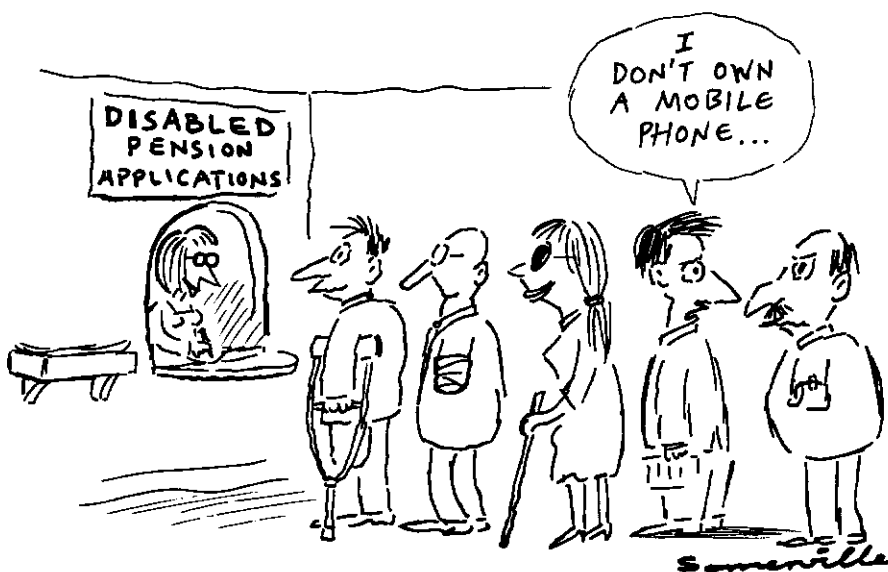

2001 SPACE ODDITIES

In a report earlier this year, I wrote that, in 1969, *Apollo 10* astronauts Stafford, Cernan and Young were the first to approach an extraterrestrial beacon (dubbed "the Monolith") and film it.

Now, with additional information, I can add that they were not, however, the first astronauts to spot this ET beacon. That Monolith was first sighted by Russian cosmonaut Yuri Gagarin, the first man in space, in 1961. He was followed that same year by American astronaut Alan Shepard who also sighted the beacon.

It turns out that sighting the beacon was not that unlikely. My ex-NSA [National Security Agency] informant said, "There are billions of them floating all over."

Dr Michael Wolf shed additional light on the beacons. "They are 'postcards from the rim'. They emit both light and tone signals, sending a mathematical language. There may be five or more ET civilisations involved in setting up these beacons."

Ignore those Boeing commercials and the NASA press releases about how America "soon" will have its own first manned space station. My ex-NSA informant revealed that there has been a manned "deep space platform" in orbit above Earth for over thirty years! "It [has] had three manned [American] crews as well as Russians 'on' since '68!" He further stated that, since 1973, the space station has received additional extremely high technology "and has had upgrades".

His disclosures confirm reports I had heard previously from former military officers about a secret space platform in orbit.

This disclosure makes clear—as does my earlier report about a secret military astronaut program retrieving the *Apollo 10* Monolith in 1972 for study—that the Cape Canaveral space shuttle launches and the "first American space station" on NASA's drawing boards are just government 'cover' programs. Such programs have served to deflect the public from becoming aware before now of the existence of a black-project military space station and classified military craft which can go well past orbit into deep space.

Additional disclosures are expected to be made, and they will be brought to you as they become available.

(Source: by Richard Boylan, PhD, LLC, 2826 O Street #2, Sacramento, CA 95816, USA, tel (916) 455 0120, website www.ufonetnetwork.com/boylan/)

SPANISH AIR FORCE DECLASSIFIES ITS 'X-FILES'

A declassification process, begun by Spain's Air Force in 1992, was completed as of 7 September 1998, according to official sources. Madrid's General Air Force Library is now the repository of 83 UFO and 'X-File'-type reports previously classified as Top Secret. An estimated 20 per cent of the cases lack any logical explanation.

A four-page report from the Spanish Air Force's Intelligence section describes what some Spanish ufologists consider the most disquieting UFO case from the Galicia region in northwestern Spain. The report, numbered 891205, describes events which occurred on 5 December 1989.

The document explains how a lenticular UFO "with a vast array of shining lights" flew at low speed "between the towns of Sada and Castro". Two hours of film also document the events.

At 6.40 pm local time, members of the Spanish state police in Castro notified the Lavacolla control tower, which in turn alerted a nearby aerial vigilance station (EVA 10) at Noia. Both civilian and military radars detected the object. The control tower requested visual reports from civilian aircraft in the area, but no civilian pilot claimed to see the object.

By 8.40 pm, three unknown objects at various altitudes were appearing on Noia's radar. The tracking was reportedly discontinued at 9.02 pm, but the signal remained on EVA 10's radar until 8.00 am the fol-

lowing morning. The official report does not furnish any explanation for the phenomenon.

According to Spanish ufologist Manuel Carballal, the incident of 5 December 1989 gave rise to "one of the most interesting 'X-Files' at the state level". But Carballal also says that the document, now housed at the Air Force Library, is "a mutilated report". Carballal claims to have gleaned more official documents than those declassified by Spain's Ministry of Defence.

Carballal cites another example of Spain's 'X-Files'. "The Defence Ministry has not found an explanation to a paranormal event which occurred on 2 April 1966 in the region of El Ferrol," he says.

The story is covered in a five-page file, number 660402.

"A corporal, a watchman and two sailors witnessed, from the A Carreira radio station, a luminous object whose shape varied every five minutes."

The phenomenon lasted 45 minutes. One of the witnesses took a snapshot of the UFO, but it only shows a white spot on a black background.

(Source: CNI News, vol. 4, no. 15, part 1, 1 October 1998; translated by Scott Corrales <Lornis@aol.com>. This text summarises portions of an original article written by R. Ventura, published in the newspaper La Voz de Galicia on 8 September 1998. Scott Corrales is creator of the online journal *Inexplicata*, the journal of Hispanic ufology; website <<http://www.inexplicata.com>>)



US Military Close Encounters in Cambodia

A retired US Army Special Forces officer claims that in 1971, while on a secret mission in Cambodia, he and his company had a terrifying encounter with humanoid aliens, and a sinister debriefing with the CIA and MJ-12.

by Linda Moulton Howe © 1998

LMH Productions
PO Box 300
Jamison, PA 18929-0300, USA
Telephone: +1 (215) 491 9840
Fax: +1 (215) 491 9842

Allegedly the United States Government has known about UFOs, their occupants and their advanced technological ability to interrupt electronic equipment since at least the Truman Administration. According to some military insiders, the United States tried aggressively in the early 1950s to bring down discs. Retrievals of crashed discs and non-human beings have been described during the 1940s, 1950s and beyond. Evidence of retrieval operations was hidden from the public inside double vaults, behind 'weather balloon' headlines and under a policy of silence in the interests of national security.

Leonard Stringfield, longtime UFO researcher since his days in the US Air Force, told me before he died that no one would ever know how many of our own pilots we lost trying to carry out orders to bring down the discs. Was our initial aggression a provocation for alien retaliation?

By the 1970s, it appears the aliens were interacting not only with nuclear missile sites but with animals, plants and humans all over the world, either with or without government knowledge and approval.

I learned about one extraordinary military interaction with grey-skinned, non-human entities from Pete Bostrom when I spoke at a Midwestern conference in 1990. (Bostrom is a Vietnam War veteran who served on active duty in the US military from 1969 to 1971 and has long had an interest in unusual phenomena.)

Bostrom handed me several typed pages and said: "Read this. It's one of the strangest conversations I've ever had with anyone in my life. If you want to use it in your work, you have my permission."

The subject was a close encounter during the Vietnam War. This is one of several eyewitness accounts I have received from men who describe having seen round, silver discs and grey beings during their respective tours in South East Asia. Some men claiming inside intelligence knowledge have suggested that extraterrestrials were covertly helping the United States during the war. Other men have implied that the non-humans used the war's violence to cover up an alien harvest of tissue and genetic material from animals and humans.

The following account describes a violent interaction between Vietnam GIs and non-human beings, in which one human attacked and a non-human responded with restraint. This incident also indicates there is an immediate, aggressive, intimidating and well-planned US intelligence response to 'handle' UFO eyewitnesses, especially those responsible enough to lead men in combat but who are not included in the need-to-know agendas of government insiders who have knowledge about non-human entities.

PETER BOSTROM'S INTRODUCTION TO AUDIOTAPED INTERVIEW

"The following is a conversation I audiotaped in the mid-1980s with the permission of a retired military Special Forces officer who served in Thailand during the Vietnam War. His special training was in electronics.

"At the time of this conversation, 'Joe' [at his request, his real name is not used] was retired and repairing television sets, VCR players and other electronic equipment in a Midwestern town. This is an account of his close encounter with several EBES [extraterrestrial biological entities] and their space vehicle.

"Unlike other countless reports of similar 'high-strangeness' meetings with extraterrestrials, this account is maybe even more interesting because it happened in wartime surroundings in Cambodia, a country supposedly out of bounds for US troops then. Plus, there is mention of MJ-12 as a government entity involved with the gathering of informa-

tion about unidentified objects in the airspace in and around Thailand, and it shows how determined the government is to extract all information it can on the subject. Also, there is mention of another strange encounter in the same general area.

"I spoke with Joe off and on for several weeks. When he spoke about this encounter, he never changed his story and I believe he wants to give the true account as he himself saw it happen. As my conversations continued with Joe around 1985, he said he had been contacted by an officer friend still on active duty who told Joe that he could freely speak about the subject of his encounter with the extraterrestrials in Cambodia and anything else concerning the subject. He said the officer told him, 'This information will be made public in the near future, anyway'. But Joe was told not to indicate specifically the true reason why he was in Cambodia.

"This other officer also talked about the UFO subject in general, and told Joe that the Roswell crash really happened and described precise methods of how people who need to see the alien vehicle and bodies are transported in high-security procedures. The officer also discussed two different alien beings. One name he used was the 'Greys' and the other was the 'Nordics'.

"Several months later, Joe said he was going back into government service. He still seemed to have government friends with high-level security clearances."

JOE'S ENCOUNTER WITH NON-HUMAN BEINGS

JOE: In September 1971, I was stationed with the Army in Thailand. Originally it was a routine mission into Cambodia close to an area called Tonle Sap, just south of Angkor Wat where the temples are. We had gone on a previous mission in answer to some problems and had gone back on a search-and-destroy mission. The area we were mainly concerned about was insurgents from the Khmer Rouge—Pol Pot's people. They were really causing havoc at the time with the local indigenous personnel. We were after one group, and when going through the jungle we heard some noises that sounded like generators or machinery. Something with a hum.

PETER BOSTROM: So, that's what attracted you?

JOE: Yes. We assumed they had some kind of refuelling station or something out there. It was quite common for the Khmer Rouge and Pathet Lao to use a high place in the jungle to make an artificial clearing for refuelling helicopters, things like that. Most of them were Russian-made and they could refuel them.

When we came into the clearing we were quite surprised to find something quite unlike what I've ever seen before. At the time, I held the rank of Lieutenant. We had with us approximately fourteen Special Forces of our country [USA] and several dozen Thai arranged with us."

BOSTROM: So you were in Special Forces?

JOE: Yes. I was originally with the 101st Airborne Special Tactical Unit. We were reassigned 506th Air Cavalry sent to Thailand. They were under the auspices of a group we won't discuss for obvious reasons. During this time, there had been several reports of some strange incidents of things flying through trees. We more or less pooh-poohed them, thinking they were people getting scared in combat.

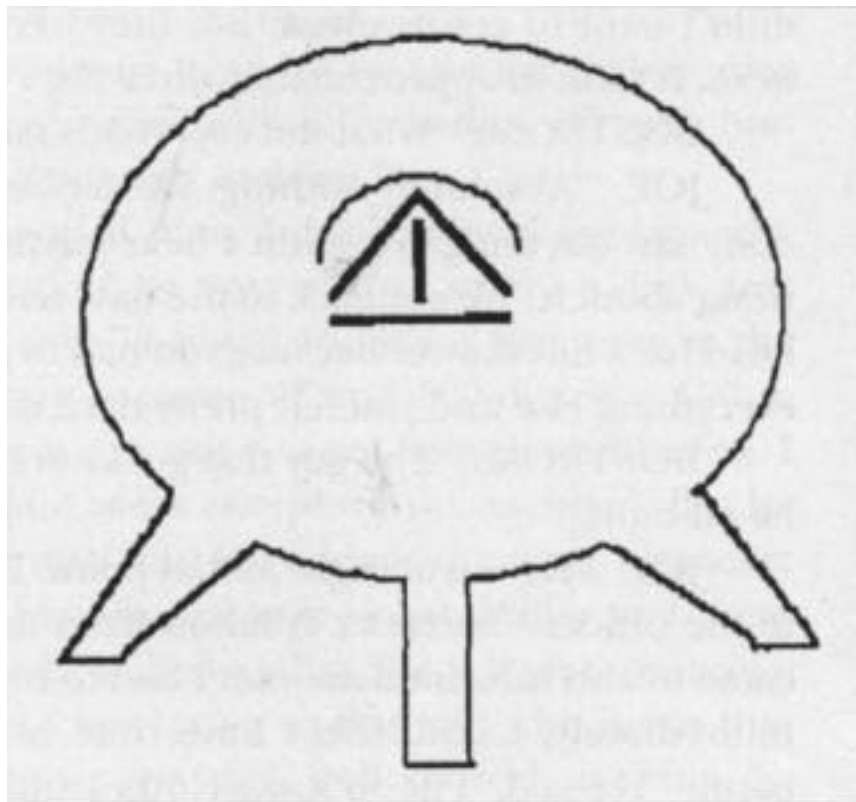

Spherical craft with symbol etched in mirrored surface that matches symbol drawn by Officer Lonnie Zamora in Socorro, New Mexico on 24 April 1964. (Drawing by Joe from 1971 encounter in Cambodia.)

We entered the clearing. What we saw was almost spherical in shape and suspended close to the ground on four legs. And there were a number of, the best description I could say, humanoids. There were at least as many of them as there were of us.

BOSTROM: How many do you think?

JOE: I would say there was anywhere between sixteen to twenty-one. Their appearance was not that of any human being I'd ever seen on Earth. Skin was a greyish-whitish colour. They were wearing what appeared to be a one-piece jumpsuit which was silver in colour, much like a metallised Mylar heatsuit. It didn't appear to be a

pressure-suit of any kind. We found out later that it was quite a strong material.

When we approached, they really didn't notice us at first; and when they did, they turned toward us. Some of the fellows [non-humans] were carrying some type of instruments. Didn't see any weapons anywhere. Made a quick judgement. It didn't look like any weapon I'd ever seen, so I thought it could be safe.

We had a young corporal with us [George]. Well, it was his second time in combat and he didn't react very well. These—I'll call them aliens—one of the aliens turned toward him with something in his hand. George evidently thought it was a weapon of some type, felt threatened and let loose a short burst of fire from a Browning FNFAL, which is literally a three-way Winchester. It has a 150-grain slug, the same hitting power as the 30-06 out to 150 yards. About the shortest burst you could fire on full auto is somewhere between 8 and 12 rounds, which, at the distance from 30 to 35 feet where it struck this fellow, would devastate a normal human being.

We were wearing flack jackets most of the time. The material [on the humanoid], whatever it was, was like the 'second chance' material we had which was a compact, lightweight, bulletproof vest. I've been struck several times with slugs wearing those—rib cage broken, you get bruised very badly, you feel like you are going to die—but as a general rule, unless it's an armour-piercing slug or some type of Teflon sliding jacket, the slugs don't penetrate. I've seen 50-calibre shells go through, but nothing much smaller than that. Nothing except high calibre and high velocity will pierce it. Occasionally a tracer will burn a pretty-good-sized hole in it. When it struck this fellow [humanoid], he went down, dropped like a stone, like he was dead. We assumed he was dead.

In that humanoid group, most of them were all approximately the same height. I would say some were five foot or less, maybe four foot eight inches, in that range. They were very small people; more like dwarves, and perfectly proportioned. Only one fellow was taller, about five-six or five-seven. He intervened at this point. I pushed the weapon down that George had in his hand. I thought, "God, this [humanoid] guy is going to kill us!"

At this point, I was terror-stricken. We didn't know who these guys were. Something like this happens, and all the science fiction movies you've ever seen in your life run through your mind. You think, "Oh, my God, are they going to pull out ray guns? Are they going to atomise us?"

BOSTROM: Did any of them ever say anything?

JOE: Never heard a single word. This fellow [taller humanoid] turned to me, evidently knowing that I was platoon commander. He raised his hand with palm out and fingers up in just a peaceful gesture and stopped and walked over to George and struck him on the cheek. It wasn't a real heavy blow. George went down like a limp rag, just like an electric shock had gone through him. The only thing I could figure was either this [humanoid] fellow is a lot stronger than we imagined

he was, or he did something else. You've seen blows, even in martial arts, that don't appear to be very heavy but have a devastating effect. George went down like a stone; just a limp rag.

About the time I was trying to pull him up, I didn't know what we were going to do at that point. I didn't want anybody else to fire because I figured if we opened fire on these guys we were dead. I was scared. I soiled my pants at that point—a nervous reaction. I didn't know quite what to do. With the exception of George, we were all veterans of at least twenty to twenty-five fire-fights. We were relatively well-seasoned combat veterans. It could have been George's third time out, but probably second, and he was green and he panicked, and I thought, "Well, he just paid the price for it. This [humanoid] fellow just killed him." But George recovered quickly.

I tried to pull George up, and turned around about the time the fellow [humanoid] that was shot [by George] got up and brushed himself off. I thought, "Oh, shit, these fellows are going to wipe us out! If an FNFA didn't take him down in eight to twelve shots, that is one tough little hombre."

The only thing I could figure was that the [bodysuit] material was tough enough that it acted as a cushion, just like a vest. We spent many times picking slugs out of our flack jackets. They smart. They will knock you out cold, sometimes, from the impact. It's like having a very large electric shock run through your body. What takes people out, knocks them out flat, is not the actual impact of the bullet but the nervous reaction of the impact, and it will literally lay you out flat before you hit the ground. Every muscle in your body goes rigid. So, I guess they [the aliens] have basically the same physiological reaction that we do.

When he [taller humanoid] turned to me and placed his palm up toward me again to stop, I had a feeling that everything was okay. I'm not going to say that it was some kind of telepathic message. It didn't really seem anything like that. It just seemed like, "Hey, it's cool. He panicked and I understand the situation."

At this point, the humanoids packed up all their little instruments, packed themselves back into the craft and left almost soundlessly. It sat there on the ground as the four legs, resting on the ground with pads on them, retracted back into the body of the craft, which was spheroid. Then it just lifted straight up off the ground. I didn't see any visible means of propulsion. There was a little noise. It was hard to tell if it was just the wind blowing through there or what. Then it was just like an instantaneous burst of speed.

BOSTROM: What do you think the diameter was?

JOE: I would say that it was at a minimum of fifty feet. It could have been as far across as 150 feet. It was very difficult to judge. It was a mirrored surface. So you're looking at something and the jungle is being reflected and it's really hard to judge the size. I know it was at least as tall as a five-storey building. What didn't make any sense is why it should be spheroid. Whatever propulsion system it required, I don't know. Perhaps it's some type of anti-gravity drive and

you'd have to have everything cantered.

BOSTROM: Was it round like a ball?

JOE: Round like a ball. Perfectly round as far as I could tell. There was one symbol on the side, of what appeared to be, I would say, black paint. Either this, or there was just no coating on this area. It was a simple symbol of an arc, almost like a pyramid with a line drawn underneath it.

[Joe drew the round craft encountered during the military operation near Tonle Sap, Cambodia, in April 1972, and wrote:

The craft was polished, highly reflective, mirrored in appearance. Spherical in shape, the craft appeared to be approximately 50 feet in diameter. Symbol on surface seemed to be ground and sandblasted, as it was less reflective. No apparent opening or door was seen until just before departure. This was evidently due to an extremely precise fit and the nature of materials involved. Although armor was not readily apparent, the surface was impervious to small-arms fire. The craft emitted a high-pitched hum, even while motionless

"...one of the aliens turned toward him with something in his hand. George evidently thought it was a weapon of some type, felt threatened and let loose a short burst of fire from a Browning FNFA, which is literally a three-way Winchester."

on the ground, and was otherwise nearly silent in its ascent. Legs appeared to be one contiguous piece with the body, but withdrew into the orb during take-off. The encounter and the description of the object were reported directly to civilians who identified themselves as representatives of 'MAJIC'.]

JOE: We returned to base. The Thais, of course, weren't going to say anything to anybody. They 'saw nothing, heard nothing', just along for the ride. Which was typical reaction for the Thais. They didn't want to get involved. But they were quite shaken by it, as we were. It took us approximately three days to get back to the border.

BOSTROM: What did everybody talk about on the way back?

JOE: Absolutely nothing. We decided on the way back that nobody saw anything. We didn't hear anything. We didn't know anything about it. We got back to the base and the first thing we did was head for a hot shower, because you had to pull all the lice off you and everything else and you felt pretty darn dirty.

BOSTROM: The guy who got knocked down—George. Was he all right?

JOE: He was alright at that point. He was a corporal and went to the officers' barracks. A fellow from the provost marshal's office came in and informed me that I had to report to the captain's office immediately. I said, "Do I have time to rinse off?" He said, "Just barely." He said, "Put on some clothes and get over there. They want to talk to you right now." I asked him what it was about. He said, "I don't know. They won't tell me. Just get your tail over there. It's something very heavy." He said they were quite confused about something.

I walked into the captain's office. We were met by the captain, a couple of majors, a colonel and some civilians. If you've ever worked with anybody with 'the Firm', they reek of it. You generally expect them in grey flannel suits and white socks, but these fellows just reeked of the Firm.

BOSTROM: What is 'the Firm'?

JOE: When you hear people involved in security, they never call a certain agency of the government 'the Company' [Central Intelligence Agency, CIA]. Insiders like to call it 'the Firm'. Again, what we were with was literally a front for the CIA's military part which it's not supposed to have. Well, it had one. Recently there have been little leaks about that. Miller [real name withheld] rode with MJ—you know, Majestic 12.

BOSTROM: MJ-12?

JOE: Right. The only way we ever heard Miller call it was 'MJ-12' or 'MJ'. We knew he worked for that. We didn't know what the heck it was. The only thing we knew was that any enemy aircraft that was sighted had to be reported to him. Any photographs we took had to be given to him. He was overly concerned about enemy aircraft, unusual sightings, anything out of the ordinary.

He'd call us in occasionally to look at photographs and say, "What is this?" And we'd say, "That's a Russian gunship, it has so much armament." He'd say, "Okay, that's what I want to know.

Thank you very much. Discuss this with no one and have a nice day."

Miller was very single-sided with information. We gave him everything. He told us absolutely nothing. He was a cold-blooded man. I don't think I ever saw the man sweat. Most of the time he wore a black suit or a dark grey flannel suit. When you're in Thailand and it's at that point in the year when it's somewhere between 97 and 100 degrees [Fahrenheit], 100 to 110 per cent relative humidity, it's so hot you get heat that's like fog. I don't think I ever saw him sweat except for this incident. But he had a cold sweat going into this. He ended up taking his jacket off—and you never saw him outside of a jacket.

Miller and these other guys sat us down and grilled us that day at least three-and-a-half to four hours. And I was trying to find out who it was that told them because when we got back, nobody said anything. So something or somebody snitched.

BOSTROM: Someone would have had to run in immediately and tell them?

JOE: We hadn't been back more than an hour. We usually took a shower, got cleaned up and got a little rest before we were debriefed because that could sometimes take many hours. It was very interesting. They even sequestered us in our quarters. We were told not to have any outside activities at all, and meals would be brought to us. We were not to talk to any unauthorised personnel. 'Authorised' meant *them*, or someone directly with authorisation from the provost marshal's office.

Then we spent the next three to three-and-a-half weeks talking to various people—some of them, I don't know who in the heck they were. Several were psychologists—it was very obvious by the kind of questions we were being asked, and they started dragging out the ink blots. We went on with this for two weeks, and then they started using narco-hypnosis.

BOSTROM: How did that operate?

JOE: Essentially, they sit you in a chair, hook up the sphygmomanometer, the blood pressure tape, and get you highly relaxed, using soothing

music sometimes, and they give you an injection of basically what is called a 'hypnotic drug'. There were drugs like Seconal, Scopolamine—the type that have a tendency to reduce what they call 'psychic resistance'. You get your body as relaxed as possible and you lose your will. They actually hypnotise you at that point. It's a combination of drugs and hypnosis. The only thing I can say that occurred during that time was that in one way or another, *they altered our memories*. [Howe's emphasis.]

Now, I do not know whether we saw something else, or they gave us a different memory and that's what we ended up with, or what we saw was much worse than what we thought had occurred and I toned it down. I *do* know that every one of us still has occasional nightmares about it and we get flashes of things that are just an incredible bloodbath.

George was reassigned from our unit after we had all cleared through medical and psychological. I was called into the captain's office approximately six or eight weeks after the incident to iden-

"Now, I do not know whether we saw something else, or they gave us a different memory..."

I do know that every one of us still has occasional nightmares about it and we get flashes of things that are just an incredible bloodbath."

tify a body they told me was George. Now, I'd seen the man on the base a few days before. The body they showed me was far, far decomposed for even the jungle, where you have rapid decomposition."

BOSTROM: But you couldn't positively identify the body?

JOE: I couldn't identify it as George. The flesh was all liquefied.

BOSTROM: So it may have been someone else?

JOE: The only thing I can say is his tissue seemed to suffer from some kind of extreme disruption, like every cell wall had been broken—like you see with a cold sore. I think whatever happened to him, they transferred him so they could show me the body and say, "That's George".

BOSTROM: Then why would they show you a body you couldn't identify?

JOE: I don't know. The people we were dealing with [MJ-12] were very, very careful about covering all avenues. They never left a thread hanging. As far as I knew, he was dead. I was called in to identify the body and sign the papers. The only way I could identify was with his dog tags. The usual thing was that during combat, because of the nature of our unit, dog tags were retrieved by a ranking officer and returned to you when you returned to base. We carried what was called 'T8407 -?-T101', which was a get-out-of-jail-free card. It was a cardboard card with two sides and department logo on one side to say the individual was allowed to be carrying strange and unusual weapons, may or may not be in uniform, and was not to be detained for any reason whatsoever. If this card is found on a body, it is to be burned with the body and reported to a telephone number and group, stateside.

BOSTROM: Is this all you can remember?

JOE: Well, that's the problem. If we really sit down and try to pressure us through it, I get confused. I talked to a couple of fellows that were involved in it, and they have the same kind of problem. Slowly but surely, things emerged; and over the years, more and more has come up. It was years before I ever had a desire at all to talk about it—not because it was frightening, or because the Firm told us not to because they were going to place it under the national security end, but because I had absolutely no desire whatsoever to talk about it.

BOSTROM: Do you remember any other details such as how the humanoids entered the craft?

JOE: It was like a section slid down; like it just created itself on the side and slid down.

BOSTROM: Do you remember a ramp?

JOE: It slid down and tilted to the ground and had a stair on it that formed a ramp for them to walk right up, with steps on it.

BOSTROM: Did it look like they were walking on steps?

JOE: It had steps on it because they were stepping, and it wasn't like they shuffled up the ramp. Their gait was very smooth, almost unerring, and they covered a lot of ground in a little bit of time. But the main problem is like I said: if we sit down and try to really go through the details and think hard about it, I end up almost with anxiety attack.

Whatever it was that they [MJ-12/CIA] did to bury those things is pretty permanent. Over the years, I still occasionally have nightmares about it. I wake up in a cold sweat and I'd remember

for awhile. It's frustrating. I find myself angry because I don't know what the heck they [MJ-12/CIA] did to us.

I did find out that a few weeks after we had our incident, there were at least two more. In one, some GIs were pinned down and two of those little [alien] fellows stepped out of the woods. One of the aliens threw a small object out between them and the Pathet Lao that had the GIs pinned down. The men described it as a 'darkness' grenade instead of a smoke grenade. It put up enough of a partition of darkness that they were able to escape. These guys came back, and others immediately came down, saying, "What the hell did they do to you guys when you saw that thing?" And they said they went through the same debriefing procedure we had to go through.

BOSTROM: What did the guys who saw the smoke bomb say about the craft?

JOE: They didn't see a craft. All they saw was the [alien] fellows that we had seen—some of the smaller ones."

BOSTROM: They just appeared there?

JOE: The men heard a noise out in the jungle and these two aliens peeked out, looked at the men who could see them clearly.

"I did find out that a few weeks after we had our incident, there were at least two more. In one, some GIs were pinned down and two of those little [alien] fellows stepped out of the woods."

The aliens turned to each other and, whatever discussion they had, one of them reached up and threw a small object; and the guys there said it couldn't have been any smaller than a tennis ball, and it went off with a loud pop—not an explosion, but a pop. It's just like a dark gas. It came up like smoke does, but it was darkness, and they looked at each other and said, "What the hell is this?!" And one of them said, "I don't care. Let's get out of here!" So they high-tailed it out. It took the Pathet Lao back far enough that they couldn't pursue the GIs. They've never seen

anything like that, and neither have we.

BOSTROM: Did they take their clothes to check for residue?

JOE: They'd done that several times. They took our fatigues.

I know that up to that point in time, I've always been fascinated with the idea of other life in the universe, but never saw enough that really made me believe that there was any such thing. But whoever or whatever those alien fellows were, I'm convinced that they're not present populace of this Earth.

Note: This text was extracted, with permission, from *Glimpses of Other Realities—Volume II: High Strangeness*, by Linda Moulton Howe, published by Paper Chase Press, USA, 1998 (ISBN 1-879706-78-4) (see review in NEXUS 5/05).

About the Author:

Linda Moulton Howe is a graduate of Stanford University, USA, and has a Masters Degree in Communication. She is a science and environmental reporter for radio and television. Her film documentaries, *A Strange Harvest* and *Strange Harvests 1993*, explored the worldwide animal mutilations phenomenon. Her books include *An Alien Harvest*, *Glimpses of Other Realities—Volume I: Facts & Eyewitnesses*, and, most recently, *Glimpses of Other Realities—Volume II: High Strangeness* (Paper Chase Press, USA, phone (702) 826 5947. Ms Howe's investigations have taken in such diverse subjects as crop circles, the *chupacabras* mystery, humanity's hidden history, and the evidence for UFOs and ETs, including research into the alleged Roswell UFO crash fragments and government knowledge and cover-up of non-human intelligences interacting with our planet.



REVIEWS

BOOKS

Reviewed by Ruth Parnell

THE FORGOTTEN MONARCHY OF SCOTLAND

by HRH Prince Michael of Albany

Publisher: Element Books Ltd, UK, 1998

ISBN: 1-86204-234-9 (502pp hc)

Price: AUD\$39.95; NZD\$59.95; £16.99;

NLGf66,90; USD\$24.95; CAD\$33.99

Available: **Australia/NZ**—Penguin Books;

UK—NEXUS office, tel 01342 322854;

Europe—NEXUS office, tel +31 0321

380558; **USA**—Element Books, tel (508)

546 1040

With interest rekindled in Scottish nationhood and a re-instated Scottish Parliament, so too is there renewed interest in Scottish sovereignty and the Royal House of Stewart (Stuart). And who better to describe the true history of the Stewarts than HRH Prince Michael, 7th Count of Albany (Scotland), a descendant of Bonnie Prince Charlie and the senior legitimate descendant of the Stuart Kings of Britain.

For *The Forgotten Monarchy of Scotland*, Prince Michael has delved into family archives and official records to construct a different picture of Stewart/Stuart history from that which successive Westminster Parliaments have presented over the centuries. Indeed, in 1807, Westminster declared direct family succession of the Stuart royal line extinct in exile.

Here we have an impressive, lively history taking in early Scotland, the rise of the Scots tradition and the High Stewards, the Stone of Destiny, the Knights Templars, key Scottish freedom-fighters through the cen-

turies, and the story of the Stewarts before and after the exile of King James VII of Scots (James II Stuart of England) from Britain in 1688—and the plots to erase the House from history.

NEXUS readers inspired by Sir Laurence Gardner's revelations on the Bloodline of the Holy Grail and the Stewarts will find this book answers many questions. Sir Laurence's succinct foreword to Prince Michael's book certainly caught my attention, as did the impressive selection of Stewart portraits and photographs.

TIME TRAVELERS FROM OUR FUTURE: An Explanation of Alien Abduction

by Dr Bruce Goldberg

Publisher: Llewellyn, USA, 1998

ISBN: 1-56718-307-7 (228pp tpb)

Price: AUD\$28.00; NZD\$33.95; £10.99;

NLGf28,90; USD\$12.95; CAD\$17.95

Available: **Aust**—Specialist Publications,

tel (02) 9736 2191; Cameron Books, tel

(02) 4758 7676; **NZ**—Peaceful Living, tel

(07) 571 8105; **UK**—Airlift Book Co., 0181

804 0400; **Europe**—NEXUS office; **USA**—

Llewellyn, tel (612) 291 1970

In *Time Travelers From Our Future*, author Dr Bruce Goldberg suggests not only that many of the humanlike beings encountered during so-called alien abductions are actually time travellers or 'chrononauts' from our future, but that such beings have helped give rise to civilisations—and have even gone back millions and billions of years into Earth's past to plant out-of-place artefacts ('ooparts') for latter-day humans to uncover!

Over the last 25 years, Dr Goldberg (a California-based former dentist turned clini-

cal hypnotherapist and author of *Past Lives—Future Lives*) has hypnotically regressed/progressed 11,000 patients, many of whom have reported encounters with chrononauts and have themselves travelled backwards, forwards and sideways in time (mentally, at least). As a result of their experiences, many of his patients developed a high degree of spiritual awareness that has changed their lives, as if this was the purpose of their encounters. According to Dr Goldberg's data from these sessions, the time travellers come from between 1,000 and 3,000 years in our future—the more technologically and spiritually advanced reportedly being from the more distant era.

Drawing on additional scientific and historical material, Dr Goldberg explains the theoretical physics of time travel and the model of a five-dimensional universe containing parallel universes. He then expands on out-of-body experiences, teleportation,



REVIEWS



BOOKS

abductions over multiple lifetimes, and the diversity of time travellers from sinister Men in Black types to the protective Guardian Angel types. Finally, he provides several self-hypnosis exercises to facilitate time travel and 'custom design' our destiny. Definitely a paradigm-changing book.

THE HEAD OF GOD: The Lost Treasure of the Templars by Keith Laidler

Publisher: Weidenfeld & Nicolson, UK, 1998

ISBN: 0-297-84129-7 (326pp hc)

Price: AUD\$39.95; NZD\$79.95; £20.00; NLGf78,90

Available: **Aust**—Allen & Unwin, tel (02) 8425 0100; **NZ**—Hodder Moa Beckett, tel (09) 478 1000; **UK**—The Orion Publishing Group Ltd, tel 01903 721596; **Europe**—NEXUS office

The more that comes to light about the history of the Knights Templars, the Grail mysteries and the true bloodline of Jesus Christ, the more piqued is public interest. But the whole story is yet to be revealed, and those who are party to the secrets must be observing this with all-knowing smiles. Still, readers with a thirst for knowledge have much to glean from *The Head of God*, written by Keith Laidler, an academic turned writer and natural history film-maker who is also a Rosicrucian.

We've heard that the Templars had 'treasures' which they spirited away from France in 1307 when Philip IV attempted to 'dissolve' the Order, but rumour has it that there

is a treasure prized above all others. In his quest for answers, Laidler pursued the notion that severed heads were used in the Templars' rituals, but one head in particular was singled out: a relic known by the name Baphomet (Father of Wisdom), which Laidler believes to be the embalmed head of none other than Jesus Christ. Laidler found he could trace the head-worshipping cult back to at least Akhenaten's Egypt (giving an alternative history of Moses and the Israelites), and through the traditions of the Druids, the Merovingian Kings, the Cathars and, of course, the Grail Knights.

While visiting what's considered to be the final resting place of the Templars' relics—Rosslyn Chapel in the west of Scotland—Laidler received insights as to the exact hiding place of this sacred relic. Unfortunately, but unsurprisingly, this is as close as he gets to uncovering the relic itself.

TOO MUCH MEDICINE? The Business of Health...Its Risks for You by Ray Moynihan

Publisher: ABC Books, Australia, 1998

ISBN: 0-7333-0652-7 (310pp tpb)

Price: AUD\$19.95; NZD\$22.95

Available: **Aust**—Allen & Unwin, tel (02) 8425 0100; ABC Shops; **NZ**—Penguin Books, tel (09) 415 4700

Is modern society suffering from a dose of too much medicine? This is the question that journalist Ray Moynihan had to ask when analysing the conflict, uncertainty and complexity surrounding the treatment of a range of health complaints. His fact-finding is the subject of his book, *Too Much Medicine?*, and accompanying documentary series for Australia's ABC TV.

Moynihan discovered to his dismay that

there is insufficient scientific evidence to support the safety and efficacy of a great deal of modern medicine's advances. For this book he looked into surgery, testing, diagnostics such as X-rays and CAT scans, implantable devices and drugs, and concluded that many of these interventions are untried, unnecessary and downright harmful. The cost of prescription drug treatments in Australia alone has risen from A\$1.5 billion in 1991–92 to nearly A\$3 billion in 1996–97, and Moynihan argues that not only are many of these drugs under-tested, they are needlessly prescribed.

Moynihan also explored the commercial context in which doctors operate, with the enormous commercial pressures exerted by the pharmaceutical industry. The corollary is that new diseases are always being identified as in need of a cure, thus new medical business opportunities and media stories are constantly being created.

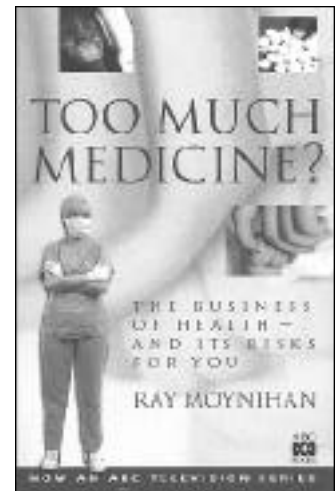



REVIEWS

BOOKS

Yet Moynihan has seen positive inroads being made into evidence-based medicine and the widening of health consumers' options. The trials currently underway in Australia in the complementary, holistic health areas will exert some influence over the direction medicine takes in the future.

Too Much Medicine? is not so much an attack on medicine and the medical profession as a call for greater public scrutiny to be applied to the business of health and for more practitioners to "lift their game".

FREE ENERGY PIONEER: John Worrell Keely

by Theo Pajmans

Publisher: IllumiNet Press, USA, 1998
ISBN: 1-881532-15-1 (472pp tpb)
Price: AUD\$45.00; NZD\$45.00; £15.95 inc. p&h; NLGf43.90; USD\$19.95 + p&h
Available: **Aust/NZ/Europe**—NEXUS offices (see page 2 for details); **UK**—

Counter Productions, tel 0171 274 9009; **USA**—Adventures Unlimited, PO Box 74, Kempton, IL 60946, tel (815) 253 6390

This is as comprehensive a biography as one can hope for on the life, discoveries and inventions of free-energy pioneer John Worrell Keely (born 1837 in Philadelphia, where he died in 1898). Despite Keely's notes having long ago disappeared, Dutch author/researcher Theo Pajmans has nevertheless pieced together a captivating history—based on newspaper articles, memoirs of those who knew Keely, and many other sources—that is timely, considering the resurgence of interest in Keely's work.

Early on in life, Keely developed a fasci-

nation for the study of vibration, but it was not until 1872, while developing his ideas and working on perpetual motion machines, that he accidentally discovered the 'force' of the ether and found a way to 'imprison' it—though it took him another 12 years to realise he had done so. For the rest of his life, Keely worked on devices which could trap this etheric force and yield abundant, 'free' energy on tap, yet he failed at commercialising his inventions despite a string of backers and a devoted patron. He also experimented with anti-gravity devices of huge lifting power, techniques for disintegrating matter, and even flying machines. The archival photos herein give an idea of Keely's extraordinary engineering talent.

Pajmans explores the 'underground' context of Keely's discoveries, in that Keely was feted by the occultists of his day who recognised that, through his technology and arguably his own psychic power, he was tapping into the same energy field that was fundamental to their own secret traditions.

THE CHINESE ROSWELL: UFO Encounters in the Far East from Ancient Times to the Present by Hartwig Hausdorf

Publisher: New Paradigm Books, 1998
ISBN: 1-892138-00-X (211pp tpb)
Price: AUD\$29.00; £10.99 + \$1.45 p&h; NLGf30.90; USD\$13.95; CAD\$20.00
Available: **Aust**—Cameron Books, tel (02) 4758 7676, fax (02) 4758 9047; **UK**—Gazelle Book Service, tel 01524 68765; **Europe**—NEXUS office; **USA**—New Paradigm Books, 22783 South State Road 7, #97, Boca Raton, FL 33428, tel (561) 482 5971, fax (561) 852 8322

This is the first of German researcher Hartwig Hausdorf's books to be published in English. Originally titled *Die Weisse Pyramide* ("The White Pyramid"), it is now called *The Chinese Roswell*, although its scope is not limited to China.

Hausdorf proposes that the ancient Chinese cult of *Hsien*, the search for 'material immortality', was influenced by what he terms 'Alien Mind'; indeed, certain pictograms and texts seem to contain knowledge of extraterrestrials and include imagery of flying jade chariots. Were these records of actual visits to Earth, or of shamanic journeys into the cosmos?

He suggests the original 'Chinese Roswell incident' took place in the Bayan Kara Ula region of western China, where an alien spacecraft allegedly crashed around 12,000 years ago. Evidence was uncovered there in 1938 of a strange, dwarfish people, and a collection of thin, incised stone-discs sup-

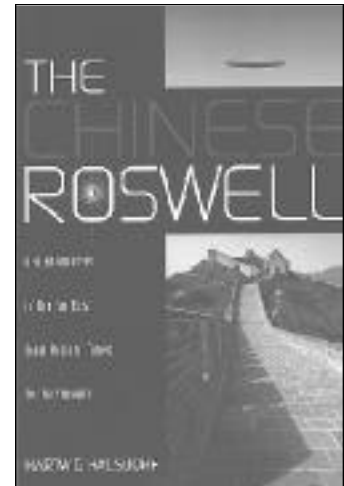

REVIEWS



BOOKS

posedly telling the story of the aliens' demise. (See NEXUS 3/01, 2/28.)

Hausdorf retraces the steps of various Western explorers to China, Tibet and Mongolia, in search of the mythical 1,000-foot-high White Pyramid, the elusive Shambhala and the ominous Monastery of the Black Khan. He also speculates on the influence of Alien Mind in Japan and the underwater city ruins off the Ryuku Islands. His coverage of modern UFO sightings in China is slighter than expected, and he falls back on already well-documented UFO encounters for comparison. It's a shame there are no photographs in this edition, but Hausdorf's book remains a fascinating read.

THE MANIPULATORS: A Conspiracy to Make Us Buy

by Jeffrey Robinson

Publisher: Simon & Schuster, UK, 1998
ISBN: 0-684-81767-5 (310pp hc)
Price: AUD\$34.95; NZD\$45.00; £17.99;
NLGf70,90

Available: **Aust**—Simon & Schuster, tel (02) 9415 9924; **NZ**—Macmillan, tel (09) 415 6677; **UK**—Simon & Schuster, tel 0171 316 1900; **Europe**—NEXUS office

It's more than 40 years since Vance Packard uncovered the insidious machinations of advertising in his book, *The Hidden Persuaders*, and in that time the techniques have only become more sophisticated, incorporating all sorts of 'breakthroughs' from the behavioural sciences.

So, while advertising serves its purpose in making people aware of products and services they would otherwise not know about,

its pervasiveness in our lives is hard to escape. And in case it's escaped our notice, Jeffrey Robinson reminds us in his new book, *The Manipulators*, that we, the targeted consumers, are a party to our own commercial seduction. *En masse*, we participate in the manipulation of our emotions and fears, whether we buy into the 'sell' or not. We can try to reduce our exposure to advertising's string-pulling, but this is fraught with logistical difficulties.

With reference to selected case studies in the history of modern advertising, marketing and retailing, Robinson exposes the techniques that are constantly being refined to capture the public's imagination and dollar. Even neurolinguistic programming has been applied in the pursuit of profit. While the arguments damning the subterfuge of mass-market selling are not new, they have quite

an impact, stacked up as they are here.

This book will be appreciated by those who have a healthy, cynical attitude towards mass-market manipulation, and probably by those industry types who wish to fine-tune their techniques of mass distraction.

ALTERED GENES—Reconstructing Nature: The Debate

edited by Richard Hindmarsh,

Geoffrey Lawrence & Janet Norton

Publisher: Allen & Unwin, Australia, '98
ISBN: 1-86448-795-X (235pp tpb)

Price: AUD\$24.95; NZD\$35.00; £12.99
(avail. May '99); USD\$/a

Available: **Aust**—Allen & Unwin, tel (02) 8425 0100; **NZ**—Archetype Book Agents, tel (09) 377 3800; **UK**—Allen & Unwin, tel 0171 7040033; **USA**—Allen & Unwin

The multibillion-dollar global biotechnology industry continues to expand its reach into myriad facets of our lives, so it's in our interests to be armed with information on its impact and become politically and socially active if we're at all concerned about where it's all heading.

As the well-known environmentalist and geneticist David Suzuki says in his reflective, sobering introduction to *Altered Genes*, the truth is that the geneticists and biotechnologists are unable to predict with certainty all the possible deleterious consequences of their experiments with life.

In order to promote informed public debate, the three editors have compiled a selection of papers (including their own) from mostly Australian and New Zealand contributors who are well-respected in their fields of biology, bioethics, consumer research, food science, genetics, human

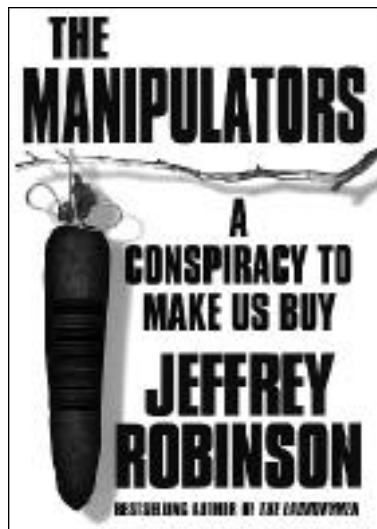



REVIEWS

BOOKS

rights, science media and sociology, and are also active in world forums. The perspectives included on the Australian biotech industry are particularly welcome, considering how underpublicised it is.

Topics covered among the 14 papers include: bio-industrial development; public relations agenda-setting; commercial opportunism; subduing dissent; eugenics; bio-prospecting and biopiracy; ethics of gene therapy; genetic privacy; problems with transgenic crops; concerns about genetically engineered foods and the new global food order; product labelling; citizens campaigns and more. *Altered Genes* is a timely edition in the interests of urgent public debate.

THE SEVENTH MILLENNIUM: The Evidence That We Can Know The Future

by John F. Ashton, PhD

Publisher: New Holland, Australia, 1998

ISBN: 1-86436-3592 (192pp tpb)

Price: AUD\$16.95; NZD\$19.95; £9.99

Available: **Aust**—New Holland

Publishers, tel (02) 9975 6799; **NZ**—New

Holland, (09) 480 0127; **UK**—New

Holland Publishers, tel 0171 724 7773

This book is a change of orientation for John Ashton, PhD, a food research chemist, a science/philosophy academic and co-author (with Prof. Ron Laura) of several well-received books on health and the environment. Here, he applies his holographic model for interpreting scientific data to the question of what the future holds.

So why the title, *The Seventh Millennium*? Well, Dr Ashton considers we're about to enter the seventh millennium of recorded human history—one that's already a focus of both fears and dreams. But, he asks, is the actual future mapped out for us and our planet, or can our choices now affect the future? In suggesting that our choices do affect the future, but only within pre-ordained limits, he brings in the idea of 'destiny fields' and 'time cycles' which influence individuals, societies and nations.

In describing a number of scientific studies of telepathy, clairvoyance, remote viewing and prayer, Ashton argues that there is a growing body of consistent evidence for the power of the human mind to see the future, and change it—but according to limits set by an organising principle, an intelligent Creator, the ultimate hologram programmer. We can choose to work in harmony with that divine hologram, or not...

Dr Ashton highlights some intriguing examples, from Babylon to today, to show

how dreams, prophecies and visions, heeded and unheeded, have changed the course of history—as they will continue to do so. He also draws on the work of scientists like Bohm and Shelldrake who are extending the boundaries of what can be explained.



SCORCHED EARTH: The Military's Assault on the Environment by William Thomas

Publisher: Earthpulse Press, USA, 1998

(first published by New Society Publishers)

ISBN: 0-86571-294-8 (228pp tpb)

Price: AUD\$34.00; NZD\$37.90;

USD\$16.95 + p&h

Available: **Aust/NZ/Europe**—NEXUS

offices; **USA**—Adventures Unlimited, PO

Box 74, Kempton, IL 60946, tel (815) 253

6390, fax (815) 253 6300

The world's military, in peacetime as well as in war, is responsible for a staggering level of destruction to the environment and to all forms of life. In *Scorched Earth*, William Thomas documents with stunning effect selected examples of this havoc—through North America, Russia, Eastern and Western Europe, the Middle East and Pacific—and its trillion-dollar repair cost. (Thomas is the author of *Bringing The War Home*, reviewed in NEXUS 5/04.)

The world's armed forces—in collusion with defence industry contractors and transnationals—are the world's greatest polluters, and Thomas devotes chapters to the vast havoc from: developing and testing all manner of weaponry and hardware; low-level supersonic flying over tribal lands; dumping of lethal toxins; using and disposing chemical and biological weapons materials; using animals and humans in genetic warfare experiments; directing EM and microwave weapons to affect people and the weather; and inflicting deliberate eco-war-

REVIEWS



BOOKS

fare on populations and their environs.

Space does not permit my going into the statistics here, but open any page in this book and you'll find many referenced examples which are truly mind-boggling. Thomas hopes the tide may be turning as the reality of clean-up costs becomes more apparent, as some new regulations are being implemented, and as grassroots groups (usually started by women) are starting to have some success in getting the military-industrial complex to take responsibility and pay for its actions and lies.

This book was first released in 1995 and needs some updating, but its messages still need our urgent attention in the late 1990s.

THE COSMIC GAME: Explorations in the Frontiers of Human Consciousness by Stanislav Grof

Publisher: Hill of Content, Australia, 1998
ISBN: 0-85572-290-8 (285pp hc)
Price: AUD\$29.95; NZD\$49.95; £12.95; USD\$19.95

Available: **Aust**—Allen & Unwin, tel (02) 8425 0100; **NZ**—Peaceful Living Publications, tel (07) 571 8105; **Ireland**—Gill & Macmillan, tel +353 1 453 1005; **USA**—SUNY Press agent, Jean Sue Johnson Libkind, tel (215) 235 9426

In his 40 years of professional life as a psychiatrist and psychotherapist, Dr Stanislav Grof has focused his research on non-ordinary states of consciousness. But to describe the particular state that interested him, he had to coin a new word: 'holotropic'—oriented towards wholeness.

Dr Grof has made an important contribution to our understanding of human consciousness and its transpersonal dimensions. His latest book, *The Cosmic Game*, is a summary of his philosophical and spiritual insights from his journeys into the "unchartered frontiers of the human psyche". With humility he admits that his insights were enriched by many thinkers, visionaries and spiritual teachers over the years—including David Bohm, Joseph Campbell, Michael Harner, Ram Dass, Rupert Sheldrake and Ken Wilber. He notes that the profound sense of cosmic unification, reported by many of his patients and experienced directly himself (originally via an LSD experiment in 1956), has much in common with ancient mystical and shamanic traditions.

Dr Grof reiterates that all life, all consciousness, desires to be reunited with its Creative Source, but the prevailing materialistic paradigm makes it difficult for this desire to be creatively expressed and integrated, especially in the Western world. As

he sees it, materialistic science cannot continue to ignore, suppress, censor or misinterpret the growing body of evidence on the validity and importance of holotropic states in human experience. If science and spirituality can be integrated, an important cosmic link will have been made.

THE HARMONIC CONQUEST OF SPACE

by Bruce Cathie

Publisher: Adventures Unlimited, 1998
ISBN: 0-932813-62-3 (216pp tpb)

Price: AUD\$27.00; NZD\$16.95; £10.95; NLGf37.90; USD\$16.95 + p&h

Available: **Aust/NZ/UK/Europe**—NEXUS offices; **USA**—Adventures Unlimited, tel (815) 253 6390, fax (815) 253 6300

First published by NEXUS in 1995, Bruce Cathie's *Harmonic Conquest of Space* has now been reissued with three new chapters. To recap, New Zealander Bruce Cathie is the (now retired) airline captain who identified a world electromagnetic grid, based on plotting UFO sightings on a map, and developed a system of harmonic mathematics to describe it. He has written many seminal books, including *Harmonic 33* and *The Bridge to Infinity*, and has described how the speed of light is not constant at every point on the Earth's surface.

The new material in this edition covers the link between atomic tests and volcanic activity—that both are influenced by the geometric relationships of the Earth and the Sun at any given time, and directly associated with the electromagnetic and unified fields inherent in the structure of the planet. To back up his argument, Cathie has calculated the geometric/harmonic relationships linking the French nuclear test at Mururoa Atoll on 5

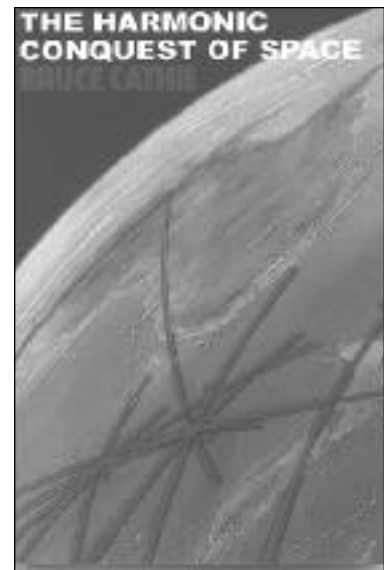



REVIEWS

September 1995 with the major eruption of NZ's Mt Ruapehu soon after.

Also covered is the harmonic geometric relationship between two massive outcrops of rock—Stone Mountain near Atlanta, Georgia, USA, and Ayers Rock in central Australia—that suggests they originated during simultaneous ripples in the unified fields. Finally, the strange, geometrically arranged stone spheres of Costa Rica are examined, Cathie postulating that they were made to tune into the electromagnetic oscillations of the harmonic unified field.

This is heady stuff, but Bruce Cathie's discoveries are opening wider the doors of our perceptions about the reality of energy and the energy of reality in the universe.

MAPPING THE MILLENNIUM: Behind the Plans of the New World Order

by Terry M. Boardman

Publisher: Temple Lodge, UK, 1998

ISBN: 0-904693-97-X (184pp tpb)

Price: AUD\$37.50; £10.95; NLGf42,90; USD\$19.95

Available: **Aust**—Rudolf Steiner Book Centre, tel 02 9264 5169; **UK**—Temple Lodge Publishing, tel 0181 748 0571, fax 0181 748 5451; **Europe**—NEXUS office; **USA**—Anthroposophic Press, Hudson, NY, fax (518) 851 2047

How true is the notion that world events are manipulated by powerful, secretive groups and individuals? In answering this, writer Terry Boardman was drawn to the anthroposophic research of Austrian esotericist Rudolf Steiner (1861–1925). Steiner, he concludes, was correct in his claims that behind some secret societies there are powers with an agenda: starting wars, directing world politics and economics, redrawing national boundaries and keeping the human spirit trapped in materialism.

To back up his argument, Boardman cites cases of where the elite has used 'influential' publications to release articles and maps which hint at their true intentions. One map, published in a satirical journal, *The Truth*, in 1890, turned out to match quite closely a redrawn Europe after WWI.

But his most recent example, an article by CFR-Rockefeller "mouthpiece" Zbigniew Brzezinski—titled "A Geostrategy for Eurasia" (*Foreign Affairs*, vol. 76, no. 5, Sept–Oct '97)—is of more immediate concern. In it, Brzezinski discusses how the world should be shaped to ensure a "benign American hegemony" with its "global primacy and historical legacy". It includes a map, "Eurasia in the 21st century", which shows a threefold division of a confederated Russia, among other surprises.

Boardman acknowledges that some of his 'proof' of an occult new world order reshaping the world is circumstantial, but he offers his book, *Mapping the Millennium*, in the "spirit of watchfulness" so that we may be awake to the greater machinations that would curb humanity's spiritual progress.

SCIENCE VERSUS TRUTH

by Cameron Horn

Publisher: Fuzcapp Publishing, Australia, 1998 (updated edition)

ISBN: n/a (454pp tpb)

Price: AUD\$22.95; AUD\$24.95 to NZ;

USD\$24.95 to UK/Europe/USA/Canada

Available: **Australia**—Fuzcapp Publishing, PO Box 2079, Gosford NSW 2250, tel 0414 706696 (mobile, in Aust), tel +61 (0)2 4323 9899

The debate between 'evolution theory' and 'creation theory' is a minefield, as evidenced in Australia in 1997 with the Ian Plimer/Alan Roberts court battle, but author Cameron Horn has not exactly cleared it with his book, *Science versus Truth*.

Horn, an award-winning writer for radio, has chosen a provocative title that suggests science and truth are diametrically opposed. He refers to numerous examples that demonstrate where Darwin's theories of evolution fall down—examples which deserve to be studied more seriously by the scientific community rather than be dismissed because they challenge the prevailing paradigm about our origins or just because they may also be sprouted by so-called 'creation scientists'. I was, however, hoping for an analysis of creation theory for the sake of balance, but that's another book.

It's clear that the evolution/creation debate



REVIEWS



remains polarised, but Horn seems to revel in as much point-scoring and nitpicking as the protagonists. Throughout the well-referenced text is a heavy dose of vitriol, directed against geologist Ian Plimer and several science writers, and enough rhetoric as to distract from his argument. Surely both 'sides' will remain polarised unless they expand their thinking to encompass alternative theories on the big questions.

Ian Plimer won't like this book, creationists will seize on its arguments to support their views, but others will find Horn's style and approach entertaining and informative.

IT'S NOT TOO LATE

by Hamish Miller

Publisher: Penwith Press, UK, 1998

ISBN: 0-9533316-0-1 (176pp tpb)

Price: AUD\$34.00; £10.95; NLGf42,90; USD\$23.00

Available: **Aust**—Sydney Esoteric Bookshop, tel (02) 02 9212 2225; **UK**—Penwith Press, PO Box 11, Hayle, Cornwall TR27 6YF, tel 01736 740401; **Europe**—NEXUS office; **USA**—Book People, tel (510) 632 4700

A near-death experience in 1982 caused Hamish Miller to undergo a profound change in his perceptions about life and the nature of reality. In the process, he developed a special bond with some guiding beings ("the Management") who seem to have humanity's spiritual progress at heart.

In his desire to maintain that sense of oneness with nature and the cosmos that these beings conveyed to him, Miller discovered dowsing to be a practical, beneficial tool for connecting and communicating with nature and for effecting energy healings. His four-year dowsing mission with Paul Broadhurst, along the St Michael and Mary ley lines in southern England, was the basis of their joint 1989 book, *The Sun and The Serpent*.

In his new book, *It's Not Too Late*, Miller encourages us to go beyond the barriers of the five physical senses and tune into the network of energy which links the Earth-based kingdoms with the cosmos. With humility and humour he says it's never too late to begin the spiritual quest, to find joy and purpose in life and to exert subtle influence on the world for the greater good of all. Ever the pragmatist (he's a blacksmith), Miller has practical advice on changing the rigid belief systems and structures that dim our true potential, and on dealing with distractions from the spiritual path.

Miller has a special gift of being able to impart wisdom while captivating the reader in the magic of his storytelling. His revelations about energetic grids, spirals and symbols in the landscape are really inspiring.

VIDEOS

Reviewed by Duncan Roads

MERKABAH: VOYAGE OF A STAR SEED (A Computer-Animated Odyssey) by James J. Hurtak & Jean-Luc Bozzoli

Producer: The Academy For Future Science, USA, 1998 (51mins)

Price: AUD\$45.00 + A\$5.00 p&h; CHF35.00; DEM39.50; USD\$19.95 +

\$3.00 p&h in USA (+ sales tax in CA) Available: **Australia**—Jewel Bould, PO Box 26, McCrae, Vic. 3938, tel/fax (03) 5986 5031, e-mail <jcj@alphalink.com.au>; **Europe**—Lakshmi Laden,

Schweibenalp, CH-3855 Brien, Switzerland, fax +41 (33) 951 4409, e-mail <affsulli@w-4.de>; **USA**—Academy For Future Science, PO Box FE, Los Gatos, CA 95031, e-mail <keys@affs.org>

What an experience!!! It's not often one can say that after watching a video! Using the very latest in computer graphics, this tape represents a view of the experience of 'The Merkabah', as inspired by the *Keys of Enoch*. Thus The Merkabah, or ultra-terrestrial vehicle represented in this presentation, is of "Light", and should not be confused with the hardware of extraterrestrial vehicles. Absolutely rivetting visuals!

UFOs: The Footage Archives

Part One: 1950-1989

Part Two: 1990-1992

Producer: 2000 Film Productions, Düsseldorf, Germany, 1998 (PAL & NTSC, each video approx. 78mins)

Price: AUD\$40.00; NZD\$60.00 + p&h; £25.00; NLGf70,00; USD\$39.95 + p&h

Available: **Aust/NZ/UK/Netherlands**—NEXUS offices (details on page 2); **Germany**—2000 Film Productions, tel +49 (0)211 35 2968; **USA**—Adventures Unlimited, tel (815) 253 6390

At last, someone has done it: made a compilation series of tapes with all those tantalising pieces of UFO film footage you may have seen at some conference or on TV. The tapes are well edited and have accompanying background music and, quite often, the sounds surrounding the event.

Highlights for me included: 1953 USAF gun-camera footage of UFOs; lots of amazing NASA archival footage, including from *Apollo 12* and a 1991 space shuttle flight; Billy Meier film footage; Gulf Breeze; the incredible Mexican UFO footage of 1991 onwards; the Brussels triangular UFO flap; and some equally wondrous shots of UFOs over Russia, Germany, Brazil, Japan and even Sydney. Definitely worth buying!



REVIEWS

AUDIO

Reviewed by Richard Giles

ENVIRONMENT

by Vulcan's Child

Producer: John Mini for Trans-Hyperborean Institute of Science, 1998 (69mins)
Distributor: **USA**—THIS, PO Box 2344, Sausalito, CA 94966, tel (415) 389 1764, fax (415) 389 6790

This CD, *Environment*, is digital, acoustic *feng shui*. John Mini, whose background is in acupuncture and *feng shui*, has created a series of CDs which can be used to balance life and environment. Working with a group of musicians as Vulcan's Child, he's composed sound patterns using abstract, natural rhythms of DNA-based sequencing. They can be played any time, to purify and upgrade your home or workplace, even while you're away. Vulcan's Child has also released *Healing* for bodywork and *Resolve* for group situations. On first listening you may find the unusual sound sequences different, but they soon grow on you. A true breakthrough in healing sound technology.

VENUS, SCULPTRESS OF LOVE

by Raymond Oliver and Ray Vanderby

Producers: Ray Oliver and Ray Vanderby for Crystal Productions, 1998 (54mins)
Distributor: **Australia**—Crystal Productions, PO Box 1277, Beenleigh, Qld 4207, tel/fax +61 (0)7 3804 5194

The Heaven on Earth music company, started by guitarist Ray Oliver in 1995, has had a number of great successes. The early album, *Heaven on Earth*, won a 1996 South Pacific International Music Award. His latest, a collaboration with keyboardist Ray Vanderby and vocalist Sharman Okan, is inspired by Shakespeare's lyrics. *Venus* has a heartfelt sincerity and manifests a love that connects directly with the soul. This is harmonious and contented music.

JOURNEY BETWEEN

by Baka Beyond

Producer: Martin Cradick for Rykomusic, UK, 1998 (52mins)
Distributors: **Aust**—Festival, tel (02) 9660 4022; **UK**—Rykodisc, tel 0181 746 1234; **USA**—Rykodisc, tel (508) 744 7678

Martin Cradick of Baka Beyond has worked hard in the last six years to bring music out of Africa to the world. He and his wife Su Hart lived and recorded music with the Baka Pygmies in Cameroon. From this they produced the albums *Spirit of the Forest* and *The Meeting Pool*—stunning combinations of their Gaelic sound and

African rhythms. This new album is a collaboration with Ghanaian band Kakatsitsi and mixes the sounds of the Jola people from Senegal into one melting pot of wonderful, flowing fusion music.

AFRO-LATINO

Producer: Dan Storper for Putumayo World Music, USA, 1998 (56mins)
Distributors: **Aust**—MRA Entertainment, tel (07) 3849 6020; **UK**—Half Moon Bay; **USA**—Putumayo Music, tel (212) 625 1400, fax (212) 460 0095

Putumayo specialises in bringing world music into the mainstream. For *Afro-Latino*, Putumayo has assembled a great collection of Afro-Cuban-Latin sounds for moving your body and making you feel good. Modern, Cubanised music from Angola, Congo, Senegal, Peru, Cape Verde and Cuba is joined in an exciting, smooth and sensual dance sound to stir the listener. There are tracks from Ricardo Lemvo, Cuban master Papi Oviedo, Congo's 4 Etoiles, Angolan music legend Ruy Mingas, and eight other bands. Easy Latin listening.

CEREMONIES

by Armen Chakmakian

Producer: Armen Chakmakian for TruArt Records, CA, USA, 1998 (56mins)
Distributor: **USA**—Electric Kingdom Dist., tel 1800 335 8584, fax (914) 693 1950

Keyboardist for the Grammy award-winning band Shadowfax from 1991–96, Armen Chakmakian leaps into his first solo album, *Ceremonies*, with a blend of new world jazz, indigenous Armenian and Arabic sounds and contemporary world music. He's joined by legendary Armenian *duduk* player Djivan Gasparayan, acoustic guitarist Alex de Grassi, John Bilezikjian on *oud*, plus several Shadowfax members. *Ceremonies* is a passionate blend of contemporary and ancient dance and rhythm that stays long after the music ends.

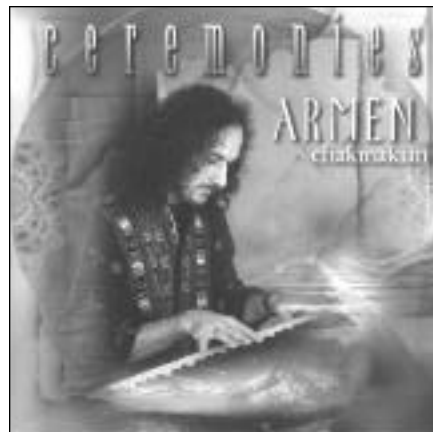

Continued from page 16

In 1770, Sir William Pitt, speaking to the House of Lords, said:

There is something behind the throne greater than the king himself.

This reference to the Money Changers behind the Bank of England gave birth to the expression, 'the power behind the throne'. In 1844, Benjamin Disraeli, in a veiled allusion to this same power, wrote:

The world is governed by very different personages from what is imagined by those who are not behind the scenes.

On 21 November 1933, US President Franklin D. Roosevelt wrote in a letter to a confidant:

The real truth of the matter is, as you and I know, that a financial element in the large centers has owned government ever since the days of Andrew Jackson...

The central bank scam is really a hidden tax, but one that benefits private banks more than the government. The government sells bonds to pay for things for which the government does not have the political wisdom or will to raise taxes to pay. But about 10 per cent of the bonds are purchased with money the central bank cre-

ates out of nothing. The government then spends this new money. Once deposited, private banks use these new deposits to create ten times as much in new fractional reserve loans. This provides the economy with the additional money needed to purchase the other 90 per cent of the new bonds without drying up capital markets and forcing up interest rates. By borrowing the money (i.e., selling new bonds), the government spreads out the inflationary effects over the term of the bonds. Thus there is little to no immediate inflation.

More money in circulation makes your money worth less. The politicians get as much money as they want, and the people pay for it in inflation—which erodes the purchasing power of their savings, fixed income and wages. The perverse beauty of the plan is that not one person in a thousand can figure it out because it's deliberately hidden behind complex-sounding economics gibberish. The full effects of the inflation are only experienced much later—too late to stop.

With the formation of the Bank of England, the nation was soon awash in money. Prices throughout the country doubled. Massive loans were granted for just

about any wild scheme. One venture proposed draining the Red Sea to recover gold supposedly lost when the Egyptian Army drowned pursuing Moses and the Israelites.

By 1698, just four years later, government debt had grown from the initial one-and-a-quarter-million pounds to £16 million. Naturally, taxes were increased and then increased again to pay for all this.

With the British money supply firmly in the grip of the Money Changers, the British economy began a wild roller-coaster series of booms and depressions—exactly the sort of thing a central bank claims it is designed to prevent.

Continued in the next issue of NEXUS...

Note: This article was extracted and edited, with permission, from the revised and updated book of the video, *The Money Masters: How International Bankers Gained Control of America*, produced by Patrick S. J. Carmack for Royalty Production Company, Piedmont, Oklahoma, USA © 1998.

The *Money Masters* book and video are available from: PO Box 4005, Joplin, MO 64803-4005; tel 1888-THE-PLOT ext. 60 (USA only), or (417) 626 0402 if outside the USA; fax (417) 626 0403. The book costs USD\$14.95 + p&h; the 2-videotape set costs USD\$39.95 + \$5.95 p&h for NTSC, USD\$44.95 + p&h for PAL. See also their website at <www.themoneymasters.com> for more ordering and contents information.

The Oiling of America

Continued from page 23

low rate of breast and colon cancer. The Netherlands and Finland both used approximately 100 grams of animal fat per capita per day, but breast and colon cancer rates were almost twice in the Netherlands what they were in Finland. The Netherlands consumed 53 grams of vegetable fat per person compared to 13 grams in Finland. A study from Cali, Colombia, found a four-fold excess risk for colon cancer in the higher economic classes which used less animal fat than the lower economic classes. A study found that Seventh Day Adventist physicians, who avoid meat (especially red meat), had a significantly higher rate of colon cancer than non-Seventh Day Adventist physicians.

Enig analysed the USDA data that the McGovern Committee had used and concluded that they showed a strong positive correlation with total fat and vegetable fat, and an essentially strong negative correlation or no correlation with animal fat to total cancer deaths, breast and colon cancer mortality and breast and colon cancer incidence. In other words, use of vegetable oils seemed to predispose to cancer, and

animal fats seemed to protect against cancer. She noted that the analysts for the committee had manipulated the data in inappropriate ways in order to obtain mendacious results.

Enig submitted her findings to the journal of the Federation of American Societies for Experimental Biology (FASEB) in May 1978, and her article was published in FASEB's *Federation Proceedings*¹⁵ in July of the same year—an unusually quick turnaround. The assistant editor responsible for accepting the article, died of a heart attack shortly thereafter. Enig's paper noted that the correlations pointed a finger at *trans* fatty acids and called for further investigation. Only two years earlier, the Life Sciences Research Office, which is the arm of FASEB that does scientific investigations, had published the whitewash that ushered partially hydrogenated soybean oil onto the GRAS list and removed any lingering constraints against the number-one ingredient in factory-produced food.

Enig's paper sent alarm bells through the industry. In early 1979 she received a visit from S. F. Reipma of the National Association of Margarine Manufacturers. Short, bald and pompous, Reipma was visi-

bly annoyed. He explained that both his association and the Institute for Shortening and Edible Oils (ISEO) kept careful watch to prevent articles like Enig's from appearing in the literature. Enig's paper should never have been published, he said. He thought that ISEO was "watching out". "We left the barn door open," he said, "and the horse got out."

Reipma also challenged Enig's use of the USDA data, claiming that it was in error. He knew it was in error, he said, "because we give it to them".

A few weeks later, Reipma paid a second visit, this time in the company of Tom Applewhite, an adviser to the ISEO and representative of Kraft Foods, Ronald Simpson with Central Soya, and a representative from Lever Brothers. They carried with them—in fact, waved in the air in indignation—a two-inch stack of newspaper articles, including one that appeared in the *National Enquirer*, reporting on Enig's *Federation Proceedings* article. Applewhite's face flushed red with anger when Enig repeated Reipma's statement that they had "left the barn door open and the horse got out" and his admission that

The Oiling of America

Department of Agriculture food data had been sabotaged by the margarine lobby.

The other thing Reipma told Enig during his unguarded visit was that he had called in on the FASEB offices in an attempt to coerce them into publishing letters to refute her paper, without allowing Enig to submit any counter-refutation as was normally customary in scientific journals. He told Enig that he was "thrown out of the office"—an admission later confirmed by one of the FASEB editors.

Nevertheless, a series of letters did follow the July 1978 article.¹⁶ On behalf of the ISEO, Applewhite and Walter Meyer of Procter & Gamble criticised Enig's use of the data. Applewhite accused Enig of extrapolating from two data points, when in fact she had used seven.

John Bailar, Editor-in-Chief of the *Journal of the National Cancer Institute*, pointed out that the correlations between vegetable oil consumption and cancer were not the same as evidence of causation, and warned against changing current dietary components in the hope of preventing cancer in the future—which is, of course, exactly what the McGovern Committee did.

In reply, Enig and her colleagues noted that although the National Cancer Institute (NCI) had provided them with faulty cancer data, this had no bearing on the statistics relating to *trans* consumption and did not affect the gist of their argument—that the correlation with vegetable fat consumption, especially *trans* fat consumption, was sufficient to warrant a more thorough investigation. The problem was that very little investigation was being done.

University of Maryland researchers recognised the need for more research in two areas. One concerned the effects of *trans* fats on cellular processes once they are built into the cell membrane. Studies with rats, including one conducted by Fred Mattson in 1960, indicated that the *trans* fatty acids were built into the cell membrane in proportion to their presence in the diet, and that the turnover of *trans* in the cells was similar to that of other fatty acids. These studies, according to J. Edward Hunter of the ISEO, were proof that "*trans* fatty acids do not pose any hazard to man in a normal diet".

Enig and her associates were not so sure. Kummerow's research indicated that the *trans* fats contributed to heart disease; and

Kritchevsky, whose early experiments with vegetarian rabbits were now seen to be totally irrelevant to the human model, had found that *trans* fatty acids raise cholesterol in humans.¹⁷

Enig's own research, published in her 1984 doctoral dissertation, indicated that *trans* fats interfered with enzyme systems that neutralised carcinogens and increased enzymes that potentiated carcinogens.¹⁸

Continued next issue...

Endnotes

1. Kritchevsky, D. et al., "Effect of Cholesterol Vehicle in Experimental Atherosclerosis", *Am. J. Physiol.* 178:30-32, July-September 1954
2. "Notice of Supelco-AOC Award to Kritchevsky", *Inform* 7:315, 1996
3. Enig, M. G., *Trans Fatty Acids in the Food Supply: A Comprehensive Report Covering 60 Years of Research*, Enig Associates, Inc., Silver Spring, MD, USA, 1995 (2ed), pp. 4-8
4. Groom, D., "Population Studies of Atherosclerosis", *Annals of Int. Med.* 55(1):51-62, July 1961; Enos, W. F. et al., "Pathogenesis of Coronary Disease in American Soldiers Killed in Korea", *JAMA* 158:912, 1955.
5. Laurie, W. et al., "Atherosclerosis and its Cerebral Complications in the South African Bantu", *Lancet*, February 1958, pp. 231-232

Continued on page 82

The Oiling of America

Continued from page 81

6. Robertson, W. B., "Atherosclerosis and Ischaemic Heart Disease," *Lancet* 1:444, 1959
7. Gordon, T., "Mortality Experience Among Japanese in the US, Hawaii and Japan", *Pul. Health Rep.* 51:270, 1957; Pollak, O. J., "Diet and Atherosclerosis", *Lancet* 1:444, 1959
8. McGill, H. C. et al., "General Findings of the International Atherosclerosis Project", *Laboratory Investigations* 18(5):498, 1968
9. Smith, R. L. and E. R. Pinckney, *The Cholesterol Conspiracy*, Warren H. Green, Inc., St Louis, MO, USA, 1991, p. 125
10. De Bakey, M. et al., "Serum Cholesterol Values in Patients Treated Surgically for Atherosclerosis", *JAMA* 189(9):655-59, 1964
11. Keys, A., "Diet and Development of Coronary Heart Disease", *J. Chron. Dis.* 4(4):364-380, October 1956
12. Cristakis, G., "Effect of the Anti-Coronary Club Program on Coronary Heart Disease Risk-Factor Status", *JAMA* 198(6):129-35, November 7, 1996
13. "Dietary Goals for the United States—Supplemental Views", prepared by the Staff of the Select Committee on Nutrition and Human Needs, United States Senate, Government Printing Office, Washington, DC, November 1977, pp. 139-140
14. Rizek, R. L. et al., "Fat in Today's Food Supply—Level of Use and Sources", *J. Am. Oil Chem. Soc.* 51:244, 1974
15. Enig, M. G. et al., "Dietary Fat and Cancer Trends—A Critique", *Federation Proceedings* 37(9):2215-2220, FASEB, July 1978

16. Applewhite, T. H., "Statistical 'Correlations' Relating *Trans* Fats to Cancer: A Commentary", *Federation Proceedings* 38(11):2435-2439, October 1979

17. Kummerow, F. A., "Effects of Isomeric Fats on Animal Tissue, Lipid Classes and Atherosclerosis", *Geometrical and Positional Fatty Acid Isomers* (E. A. Emken and H. J. Dutton, eds), American Oil Chemists Society, Champaign, IL, USA, 1979, pp. 151-180; Kritchevsky, D., "Trans Fatty Acid Effects in Experimental Atherosclerosis", *Federation Proceedings* 41:2813, 1982

18. Enig, M. G., "Modification of Membrane Lipid Composition and Mixed-Function Oxidases in Mouse Liver Microsomes by Dietary *Trans* Fatty Acids", Doctoral Dissertation for the University of Maryland, 1984

About the Authors:

• **Mary G. Enig**, PhD, is an expert of international renown in the field of lipid biochemistry. She has headed a number of studies, in America and Israel, on the content and effects of *trans* fatty acids, and has successfully challenged government assertions that dietary animal fat causes cancer and heart disease. Recent scientific and media attention on the possible adverse health effects of *trans* fatty acids has brought increased attention to her work.

Dr Enig is a licensed nutritionist, certified by the Certification Board for Nutrition Specialists, a qualified expert witness, a nutrition consultant to individuals, indus-

try, and state and federal governments, a contributing editor to a number of scientific publications, a Fellow of the American College of Nutrition, and President of the Maryland Nutritionists Association. She is the author of over 60 technical papers and presentations, as well as a popular lecturer.

Dr Enig is currently working on the exploratory development of an adjunct therapy for AIDS using complete medium-chain saturated fatty acids from whole foods. She is the mother of three healthy children brought up on whole foods including butter, cream, eggs and meat.

• **Sally Fallon** is the author of *Nourishing Traditions: The Cookbook that Challenges Politically Correct Nutrition and the Diet Dictocrats* (with Pat Connolly, Executive Director of the Price-Pottenger Nutrition Foundation, and Mary G. Enig, PhD), as well as of numerous articles on the subject of diet and health. She is Vice President of the Price-Pottenger Nutrition Foundation and editor of the Foundation's quarterly journal. She is the mother of four healthy children raised on whole foods including butter, cream, eggs and meat.

Sally Fallon's publications may be obtained by contacting the Price-Pottenger Nutrition Foundation in San Diego, California, USA, on (619) 574 7763.